

mitsubishi

GENERAL-PURPOSE AC SERVO

MELSERVO-SA-R

— Instruction Manual —

Thank you for your purchase of Mitsubishi MELSERVO-SA-R. This instruction manual describes handling, installation, operation and maintenance of your AC servo system. Although it is easy to use the AC servo amplifier and motor, inadequate use and operation might cause unforeseen trouble. Before operating your system, read this manual carefully to use the system for a long time without problems.

CONTENTS

1. UNPACKING AND CHECKING	1
2. HANDLING	1
3. INSTALLATION	2
3-1 Servo amplifier	2
3-2 Servo motor	3
4. EXTERNAL WIRING AND CONSTRUCTION	8
4-1 Standard wiring diagram	8
4-2 Connection of regenerative unit	10
4-3 PLG cable assembly	11
4-4 Common line	12
4-5 Signal circuit construction	13
4-6 Cautions for wiring	18
4-7 Countermeasure against noise	23
4-8 Structure of input/output terminals	27
5. OPERATION OF KEY SETTER	31
5-1 Display description	31
5-2 Operation of key setter (MR-SU)	33
6. OPERATION PROCEDURE	39
6-1 Initialization	39
6-2 Precautions before operation	43
6-3 Operation	44
6-3-1 Roll feed mode operation	45

6-3-2	Positioning mode operation	50
6-3-3	Step positioning operation with stored data	58
6-4	Servo gain setting	61
7.	TROUBLESHOOTING	65
7-1	Investigation procedure and countermeasure for alarm occurrence	65
7-2	Troubleshooting	72
8.	MAINTENANCE AND INSPECTION	76
8-1	Cautions and inspection	76
8-2	Voltage and current measurement	77
8-3	Periodic inspection	78
8-4	Storage	79
8-5	Layout on the printed circuit board	80
9.	INPUT/OUTPUT TERMINALS	86
9-1	Description of terminals	86
9-2	Input/output interface	89
10.	DISPLAY AND PARAMETER LIST	91
10-1	Operation status monitor	91
10-2	Diagnosis indication	93
10-3	Alarm indication	94
10-4	Parameter	95
10-5	User parameter setting data	97
10-6	Special parameter data	102
10-7	Parameter setting value entry table	103

1. UNPACKING AND CHECKING

After unpacking the MELSERVO-SA, check the following points at first.

- (1) Check the nameplates of amplifier and motor to make sure the models and output ratings meet your order.
- (2) Check that the amplifier and servo motor have not been damaged during transportation.

If you have any question or find trouble with your MELSERVO-SA system, contact nearby-located our sales representative.

2. HANDLING

Carry and handle the servo amplifier and motor carefully to avoid damage to them.

- (1) The cover of servo amplifier is made of steel sheet. When the servo amplifier is carried, do not hold it in such a manner that force is exerted on only the cover.
Do not place an object on the cover. Otherwise the cover might be deformed or damaged.
- (2) Carefully handle the encoder of servo motor and use care not to give mechanical impact to it.
When carrying the motor, do not apply hand or slinger to the encoder to lift.
- (3) Servo motor having capacity larger than that of HA-SA202 comes with eye bolts.
To lift and transfer such a servo motor, install the eye bolts and apply wire ropes, hooks, etc. to them.

3. INSTALLATION

3.1 Servo amplifier

- (1) Install the servo amplifier in a clean and well-ventilated location. Do not install the servo amplifier to direct sunlight, high temperature, high humidity, dust and corrosive gases.

Environmental conditions

Ambient temperature	0°C to 55°C (to be free from freezing)
Ambient humidity	90% RH or less (to be free from condensation)
Vibration	0.5G or less

- (2) The servo amplifier is of wall-mount type. Install it on a wall vertically and securely with bolts or screws so that the letters "MELSERVO-SA" face front. (see the figure below).

- (3) Since the servo amplifier generates heat during operation, provide sufficient clearance (at least 40mm around the servo amplifier (see the right figure).

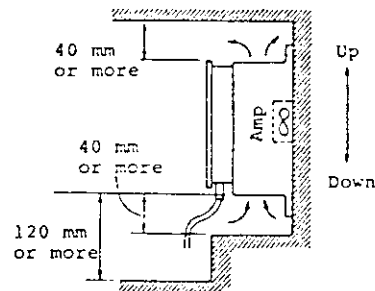

- (4) When the servo amplifier is housed in a cubicle, enclosure, etc., pay attention to prevent deposit of dust in the unit.
- (5) Discharge resistor for brake (option) may become hot when operation is repeated frequently. Do not install it directly on a wall susceptible to heat.

3-2 Servo motor

- (1) Do not install the servo motor to direct sunlight, high temperature and high humidity.

Environment

Ambient temperature		0 - 40°C (to be free from, freezing)
Ambient humidity		80% RH or less (to be free from, condensation)
Vibration	1.5kW or less	X: 1G Y: 2.5G
	2, 3.5kW	X: 2G Y: 5G
	5, 7kW	X: 1.2G Y: 3G

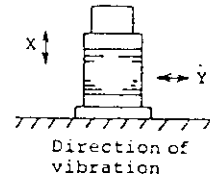

- (2) If the servo motor may be exposed to water or oil, protect the motor with a cover or other suitable means and install the motor with the leads directed downward so that water or oil cannot run into the motor along the leads (see the figure).

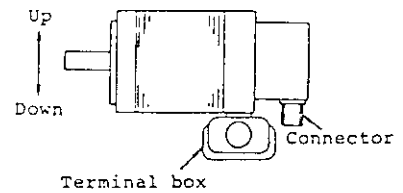

- (3) When the motor is vertically or slantly mounted, provide a trap for cable.

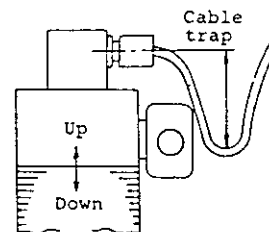

- (4) The cable sometimes guides oily water to the motor or detector to take an adverse effect on it. Take care to prevent the cable from guiding oily water or dipping in the oily water pan.

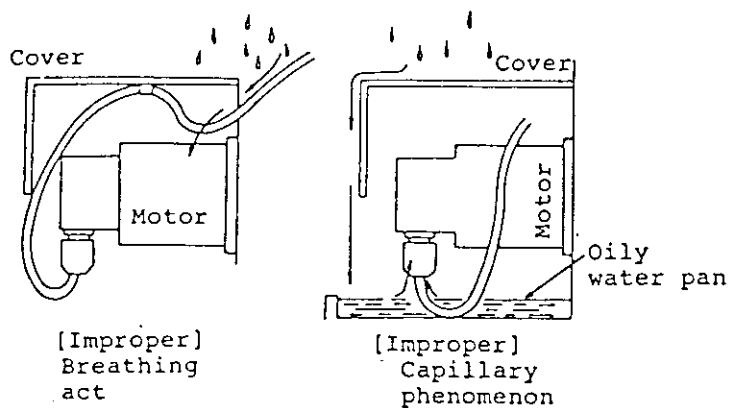

- (5) Sufficiently check the cable clamp method, and prevent the cable connection area from being exposed to the bending stress or the weight stress of the cable itself.
- (6) In the application where the motor is moved, determine the curvature radius of the cable judging from the bending durability and cable type.
Take care to prevent the cable sheath from being cut by sharp cut chips, torn with the corner or the machine or stepped on by man or cart.
- (7) The servo motor is horizontally mounted, and the spindle can be faced upward or downward as desired.
- 1 When the spindle is faced upward, take some countermeasure to prevent oil from entering the motor from the gear box or similar. In this case, only the oil seal provided on the motor can not prevent entry of the oil.
 - 2 The motor provided with electromagnetic brake is also horizontally mounted, and the spindle can be faced upward or downward as desired.
When it is faced upward, vibration of the brake plate may result in sounding. But it is not an abnormality.
 - 3 The motor provided with reducer can not be operated in any other position except shown in the outline drawing. Use the motor as specified in the outline drawing.
 - 4 When the motor is horizontally mounted, always keep the oil level lower than the oil seal ripple of the

servo motor shaft, and provide the air breather port on the gear box to prevent the inner pressure from rising. If it is higher than the oil seal ripple, oil may enter the motor.

Model	Standard	HA-SA22 HA-SA33	-	HA-SA52,53 to HA-SA 152, 153	HA-SA202 to HA-SA702	-
	Low inertia	-	-	HA-SA52L HA-SA152L	HA-SA202L HA-SA302L	HA-SA502L HA-SA702L
	Pancake	-	HA-SA32U HA-SA52U	HA-SA102U to HA-SA302U	-	HA-SA502U
Height from the motor shaft center h (mm)		11	15	20	25	30

Note: For geared motors, some restrictions are imposed on installation. Install such a motor in accordance with the applicable drawing.

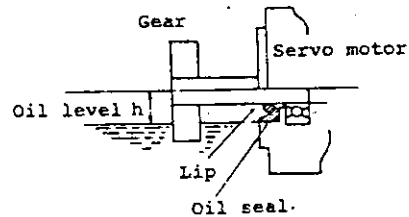

(8) During transportation and installation, use care not to give mechanical shock or impact to the encoder of motor.

Do not hold the encoder by hand, nor apply a wire rope or slinger to the encoder to lift the motor.

In installation or assembly, do not hammer the motor end.

Do not change orientation of the encoder.

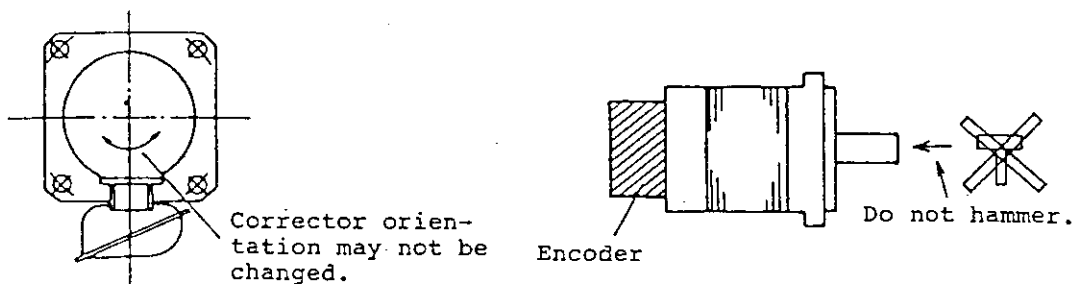

(9) For connection of the motor shaft to a machine shaft, it is recommended to use a "flexible coupling" which can automatically adjust misalignment of two shafts. When the motor is secured in position, be sure to align its shaft with the shaft of the associated machine. Upon periodic inspection, check shaft alignment and correct if necessary.

(10) Do not exert a load exceeding the limit shown below to the motor shaft.

Series	Motor	Permissive radial load	Permissive thrust load
Standard	HA-SA22, 33	L=25 20kg	15kg
	HA-SA52, 53(T) to HA-SA152, 153(T)	L=55 100kg (L=58 40kg)	50kg
	HA-SA202 to HA-SA702	L=79 210kg	100kg
Pancake	HA-SA32U HA-SA52U	L=35 30kg	20kg
	HA-SA102U HA-SA202U	L=55 65kg	50kg
	HA-SA302U	L=65 100kg	60kg
	HA-SA502U	L=79 210kg	100kg
Low inertia	HA-SA52L to HA-SA152L	L=55 100kg	50kg
	HA-SA202L HA-SA302L	L=79 210kg	100kg
	HA-SA502L HA-SA702L	L=85 250kg	100kg

Notes:

1. The permissive thrust load and permissive radial load are applicable when they work independently.
2. The permissive radial load parentthesized with () is applicable for the taper-shafted motor.
3. The codes in the table are as follows:

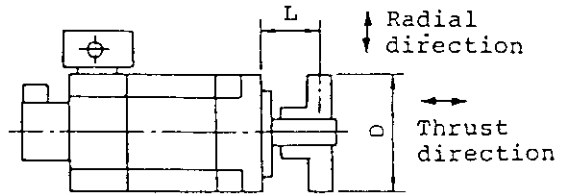

L: Distance (mm) from the flange mounting surface to the center of the load.

- (11) The servo motor shaft is not provided with key groove. For connection of the motor shaft with a machine shaft, use a coupling requiring no key.

(2) Standard connection diagram for positioning mode

- *1. This diagram is applicable to 0.5 - 5.0 kW models. Please refer to 4-2 when a regenerative option is used. Regenerative unit must be installed in case of 7.0kW model.
- *2. When the emergency stop circuit is installed, a short wire in B-R terminals must be removed.

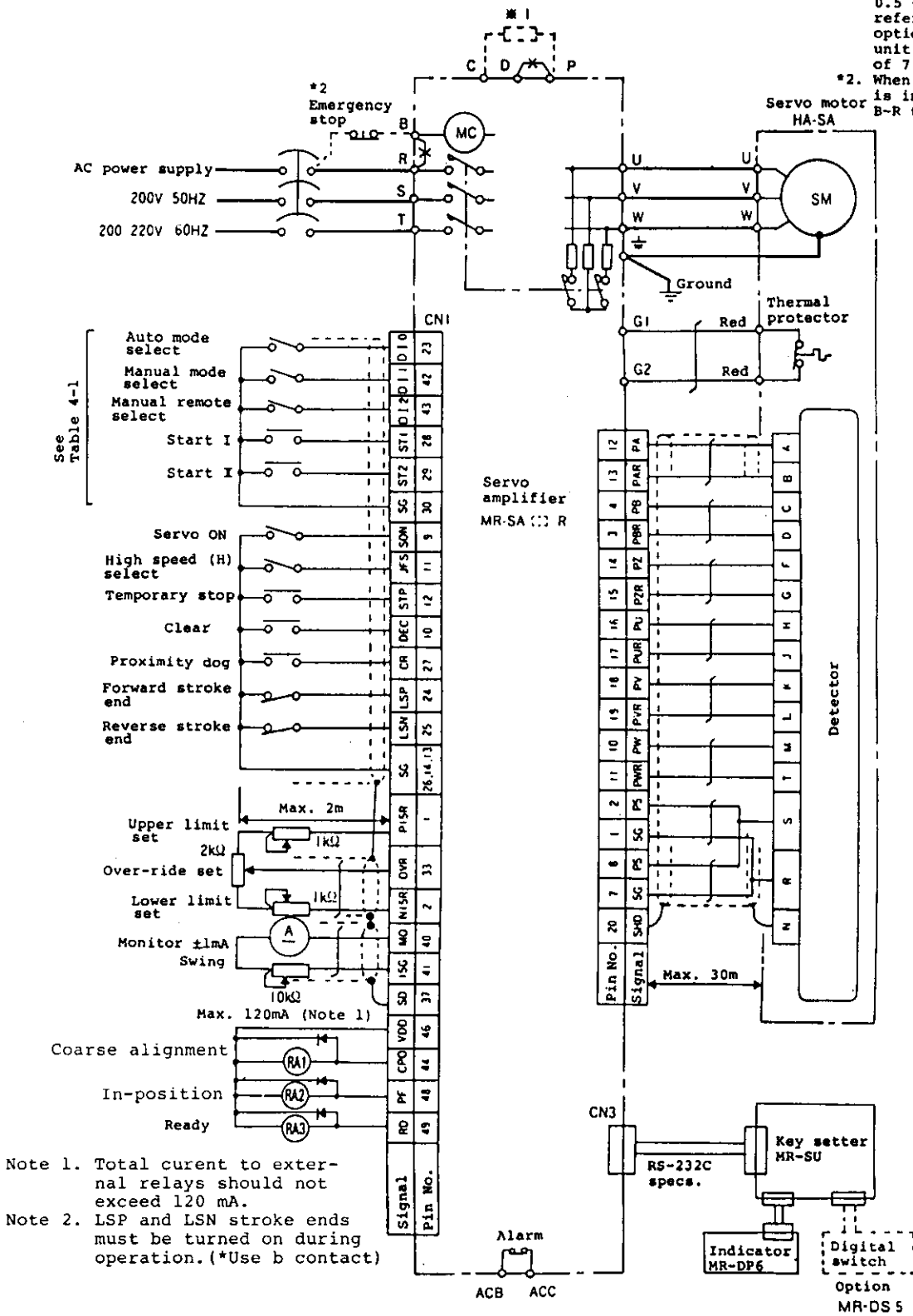

Fig. 4-2 Standard connection diagram for positioning mode

4-2 Connection of regenerative unit

When the regeneration frequency is high and the regenerative unit is used, it is wired as shown below. Since the external mount type regenerative unit is standard in case of 7.0kW type, be sure to connect the unit.

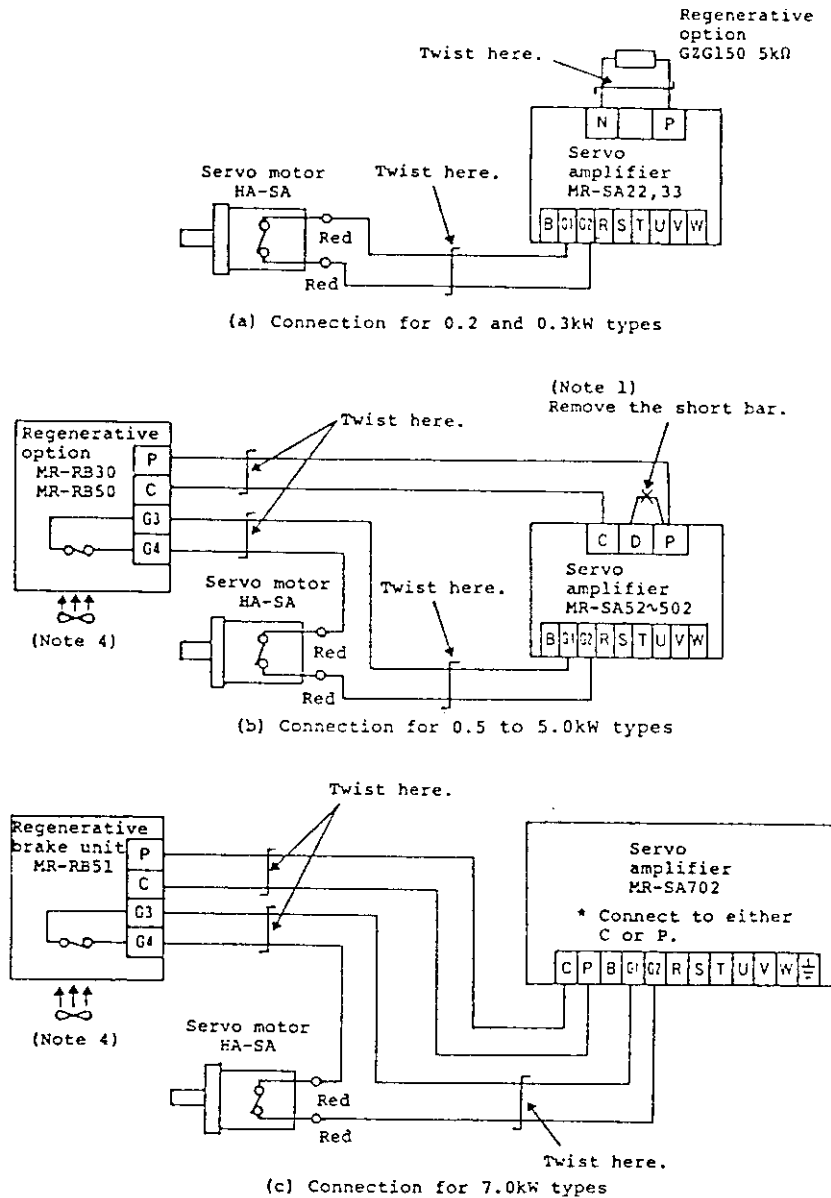

Fig. 4-3 Connection for regenerative unit

Cautions for operations

- When the regenerative option is used, be sure to remove the short-bar (D to P) of the servo amplifier (in case of 0.5 to 5.0kW types). When operated with the short bar attached, the amplifier may be broken.
- After the regenerative option is wired, be sure to twist the cables. Make the cables the shortest possible (5m or less).
- Be sure to use the twisted cables for wiring the temperature detector. Prevent malfunction caused by inductive noise.
- When MR-RB50 or MR-RB51 is used, it must be forcibly cooled down with the cooling fan (3.5m/sec 92mm square size).
- Since the main body itself of the regenerative option generates heat, don't mount it directly on the wall surface which is weak against heat.

4-3 PLG cable assembly

The connection cables between the motor PLG and the servo amplifier shall be arranged as shown below. When ordering the cable (in case of 0.2mm² core cable), specify the model name of the cable assembly corresponding to the necessary cable length.

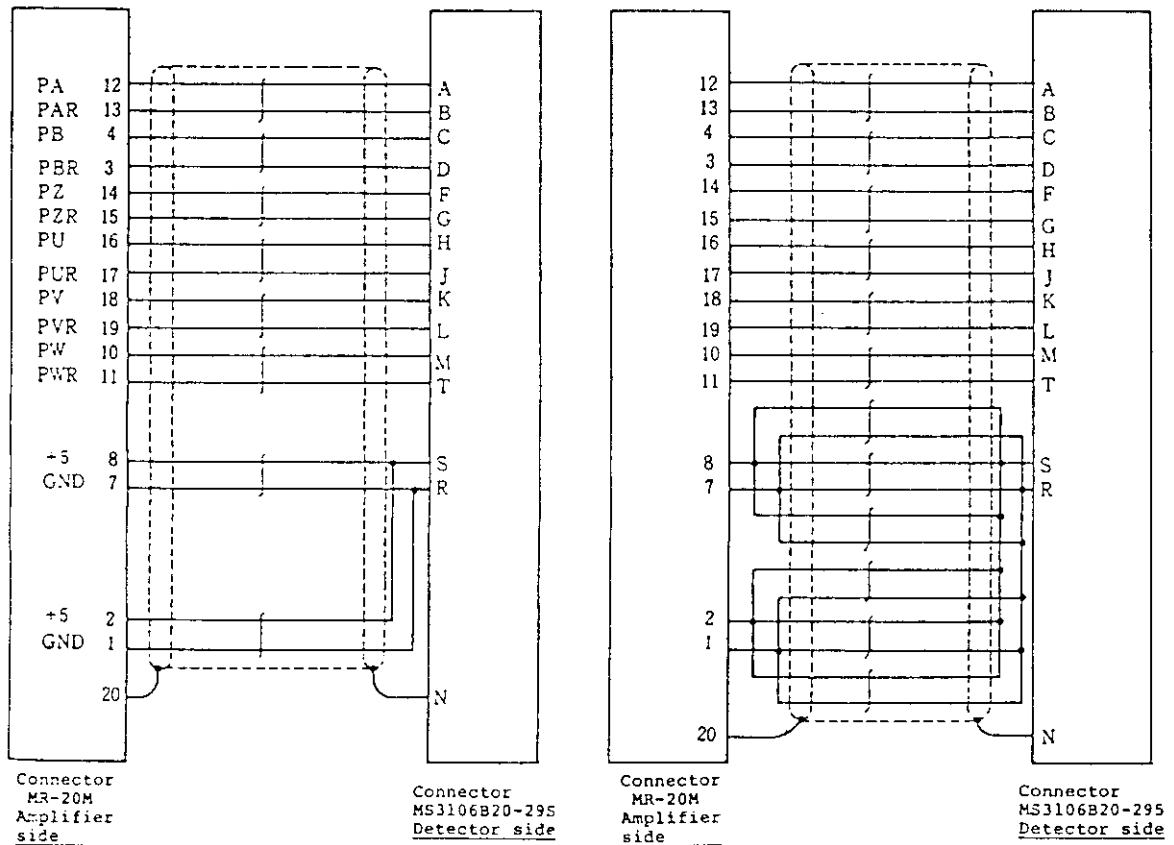

(a) MR-SACBL5M(5m)

(b) MR-SACBL10M-SACBL30M(10m-30m)

Fig. 4-4 PLG cable connection diagram

4-4 Common line

The common line in the servo amplifier is shown below. The digital input and output signals are insulated from the internal circuit with the photocoupler. The analog output signal is connected to the pulse series output signal with the internal common line. If it is liable to be influenced by external noise, ground the LG terminal.

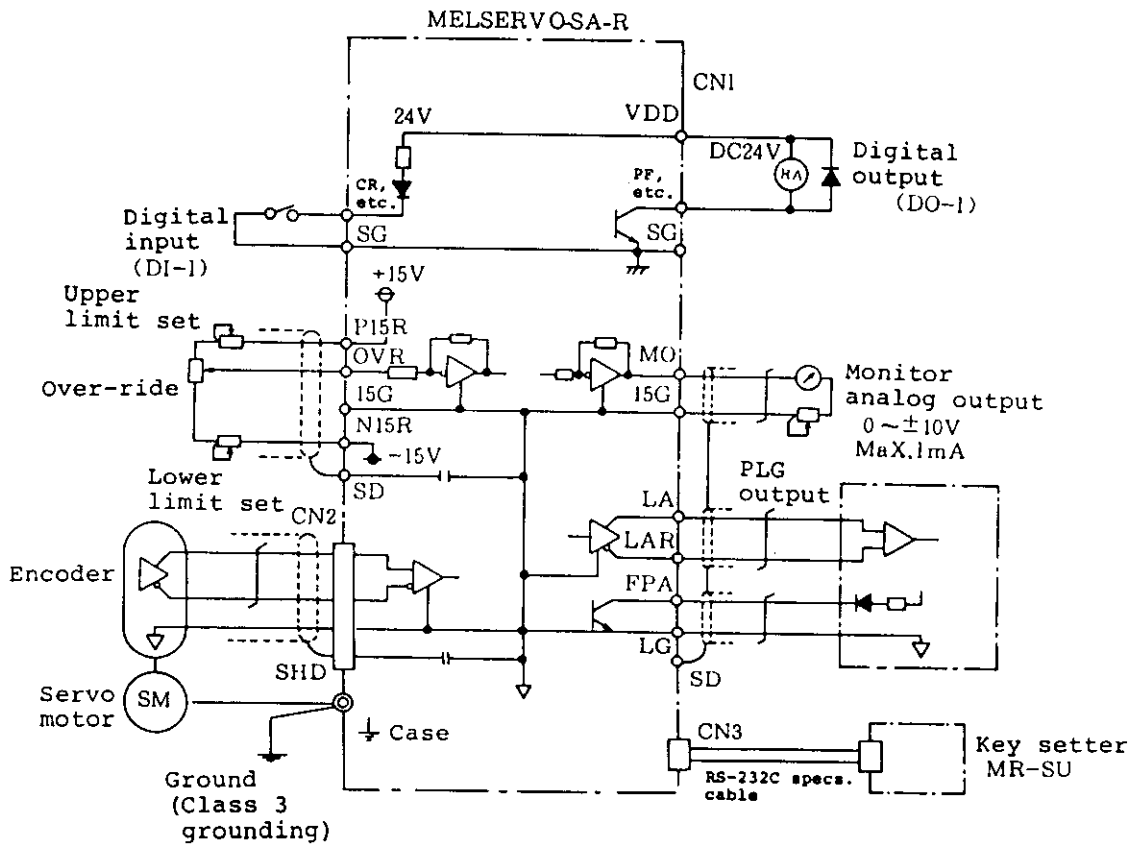

Fig. 4-5 Common line in servo amplifier

4-5 Signal circuit construction

(1) Power on sequence

① Servo On (SON) signal

Input signal which activates the main circuit of servo amplifier. Main circuit contactor is disconnected with SON signal Off and the dynamic brake circuit is formed.

Note 1. The dynamic brake will be activated only when the motor is revolving. It has no holding capacity while the motor is not running so that an electromagnetic brake is necessary to prevent the fall on the vertical shaft at power failure.

2. Please note that too much frequent On-Off of SON signal may cause some troubles. Be sure also to use dedicated external input signals to start or stop the operation.

② Standard connection

Control circuit will be turned on when 3-phase power is applied to R, S, and T.

If the servo On signal is turned on after a pause of max. 1 second (usually 0.3 sec.) which is necessary to initialize the inside of [MELSERVO], an inner contactor (MC) is tripped, the power is supplied to the main circuit simultaneously with the release of dynamic brake and the operation can be started. When SON signal is turned Off, the dynamic brake will be activated.

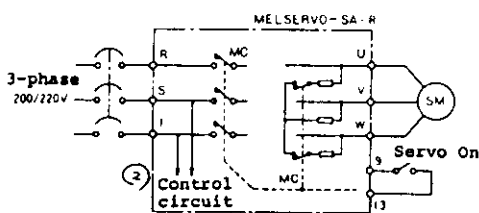
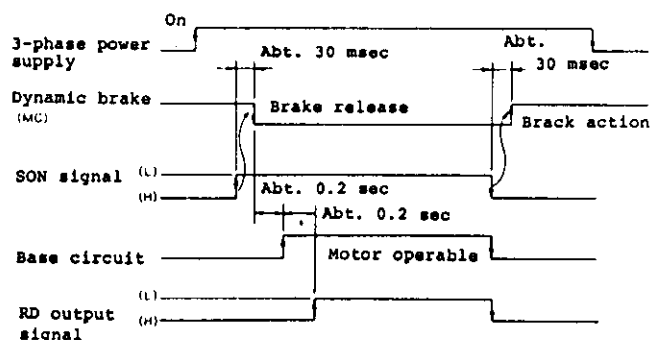

Fig. 4-6 External connection of main circuit



Timing chart at power on

③ Emergency stop

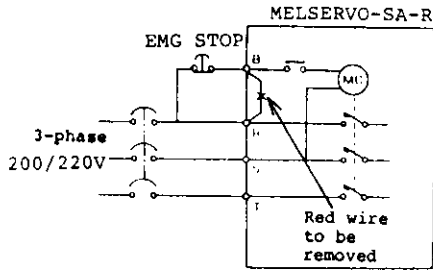

Fig. 4-7 External connection of main circuit

A short wire (B-P) at internal wiring side of servo amplifier terminal board can be removed and, instead, an external emergency stop button (push/pull button) can be installed. If the button is pushed, a contactor (MC) drops and the motor can be stopped immediately by the action of dynamic brake. RD output signal will

be turned Off at the same time.

Note: Please note that frequent On/Off of MC may cause unexpected trouble because it features the condenser input method. It should not be used as the signal to command the start/stop of motor.

④ Timing chart at the occasion of alarms

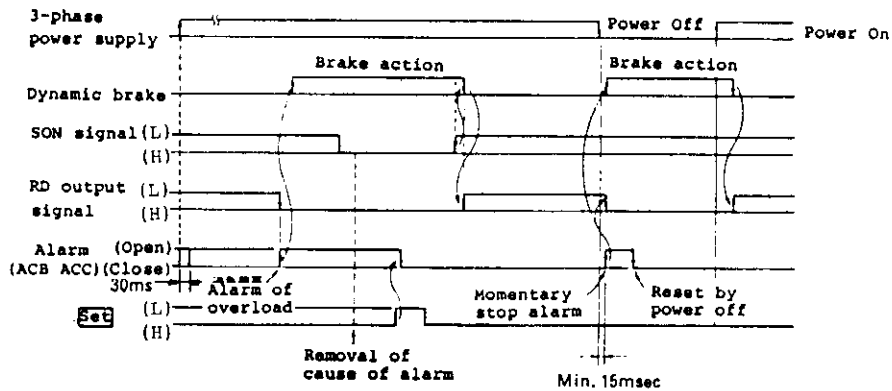

Note 1. To reset the alarm, press **Set** key of key setter or turn off the power and then back on again. Please note that the alarms with code Nos. 16-37 and 60 cannot be reset with **Set** key. Refer to the chapter 7 for the details of causes of alarm and the method of reset.

2. Repeated reset operations at such alarms as the overcurrent or overvoltage may generate an unusual heat and result in the damage on amplifier. Be sure to wait about 30 minutes for cooling before resuming the operation.

3. Momentary power failure of 15 msec or more will activate the protective circuit. If the power is interrupted for more than 10 msec (20-30 msec), the protective circuit will be reset automatically. When the power is backed on, the circuit will be set at the initial state. In such occasion, if SON signal and the operation command are left as they were at the power failure, the motor starts to turn with the restoration of power supply. In order to avoid unexpected accident, any adequate external sequence must be contrived to turn off SON and operation command signals by means of alarm.

Fig. 4-8 Timing chart at the occasion of alarms

(2) Sequence of external signals

① Relations between various start signals and mode select signals

Various start signals have following meanings depending on conditions of setting of feed methods and selection of modes.

Table 4-1 Relations between various start signals and mode select

Feed method		Roll feed type			Positioning type				
Operation mode		Auto	Manual	Manual remote	Auto	Auto zero return	Manual	Auto zero return	
Operation mode select signal, Note 1	D10	o	x	x	o	o	x	x	
	D11	x	o	o	x	x	o	o	
	D12	x	x	o	x	o	x	o	
Start signal, Note 3, 4	External input signal	ST1		-		Note 5 			
		ST2	-	-		Note 6 			-
		STP			-				-
	Key setter	Reverse inching Forward inching	-		-	-	-		-
		1 sheet feed	-		-	-	-	-	-

- Note 1. Circle in the column of operation mode select signal means ON and x mark means OFF. When the operation mode select signal is switched during the manual or the manual remote operation, the speed slows down and stops. It will be neglected during the auto mode operation but it will be effective at the next operation after stop.
2. Action of \lrcorner takes place at the edge of touch up of input signal but it is ineffective if it is input during operation. \lrcorner is activated while the signal is input and, when the signal has passed away, the speed slows down and stops.
 3. Delay time to take in the start signal (\lrcorner) ON is 10 ms or less.
 4. About 50 ms shall be secured for the start signal (\lrcorner) ON.
 5. In case of absolute system, ST1 turns out to be a start signal toward the set position.
 6. In case of increment system, ST2 turns out to be the start of reverse start while it allows to return to No. 1 step in case of step positioning based on stored data.

② Start/stop signals

- I. It is necessary to arrange the sequence so that the start signal will be input after the main circuit has been established. It will be neglected if it is input before the main circuit is established. Normally, it is interlocked with the signal of preparation complete (RD).
- II. Start in the servo amplifier is executed by catching the touch up edge of external start signal but it takes a max. 10 ms delay for the processing within servo amplifier. Other signals take the max. 50 ms delay respectively. (See the bottom left figure) (See the left figure on the next page.)
- III. Be sure to secure 50 ms for the duration of On of start/stop signals in order to prevent erroneous motions against varying reaction of PC, etc.

IV. Auto start signals can not be accepted while it is BUSY. Make sure to input these signals after the rough concordance signal, with its output range being set at zero, is output or after the positioning complete signal is output. (See the right figure on the next page.)

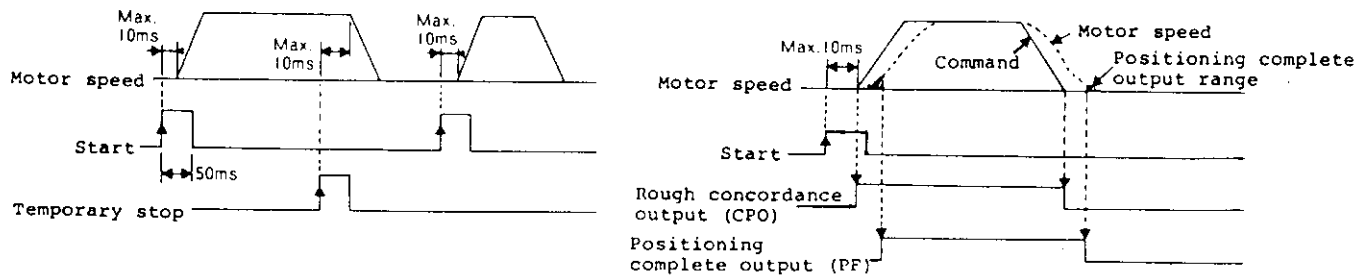

4-6 Cautions for wiring

(1) Main circuit

Table 4-2 Cautions for wiring (main circuit)

	Description																																																						
AC power supply	<p>1. For AC power supply, 200V supply is used. If available power supply is 400V, use an insulating transformer to provide 200V supply. Single-phase operation is impossible.</p> <p>2. Capacitor is used in the primary supply circuit. Immediately after the power is turned on, large current flows for charge of the capacitor and may cause voltage drop. Consequently, it is recommended that programmable controller, if used together with the servo amplifier, is fed with independent power.</p> <p>3. The reactor which improves the power factor can not be used. Because it may brake the amplifier.</p>																																																						
Magnetic brake power supply	<p>For the motor magnetic brake, DC24V is used. Note that servo amplifier driver power supply "VDD" (DC24V) may not be used to drive the magnetic brake.</p>																																																						
Cable size and no-fuse breaker	<p>Recommended cable/wire size and no-fuse breaker are listed below.</p> <table border="1" data-bbox="533 1570 1291 1883"> <thead> <tr> <th rowspan="2">Model</th> <th rowspan="2">No-fuse breaker</th> <th colspan="5">Wire size mm²</th> <th rowspan="2">Magnetic brake</th> </tr> <tr> <th>R, S, T, $\frac{1}{2}$</th> <th>U, V, W</th> <th>P, C</th> <th>G1, G2</th> </tr> </thead> <tbody> <tr> <td>MR-SA 22, 32, 33</td> <td>NF30 type 5A</td> <td>2</td> <td>2</td> <td>2</td> <td rowspan="8">1.25</td> <td rowspan="8">1.25</td> </tr> <tr> <td>MR-SA 52, 53</td> <td>NF30 type 10A</td> <td>2</td> <td>2</td> <td>2</td> </tr> <tr> <td>MR-SA 102, 103</td> <td>NF30 type 15a</td> <td>2</td> <td>2</td> <td>2</td> </tr> <tr> <td>MR-SA 152, 153</td> <td>NF30 type 15A</td> <td>2</td> <td>2</td> <td>2</td> </tr> <tr> <td>MR-SA 202, 203</td> <td>NF30 type 20A</td> <td>3.5</td> <td>3.5</td> <td>2</td> </tr> <tr> <td>MR-SA 302, 352</td> <td>NF30 type 30A</td> <td>5.5</td> <td>5.5</td> <td>2</td> </tr> <tr> <td>MR-SA 502</td> <td>NF50 type 50A</td> <td>5.5</td> <td>5.5</td> <td>3.5</td> </tr> <tr> <td>MR-SA 702</td> <td>NF100 type 75A</td> <td>8</td> <td>8</td> <td>3.5</td> </tr> </tbody> </table>	Model	No-fuse breaker	Wire size mm ²					Magnetic brake	R, S, T, $\frac{1}{2}$	U, V, W	P, C	G1, G2	MR-SA 22, 32, 33	NF30 type 5A	2	2	2	1.25	1.25	MR-SA 52, 53	NF30 type 10A	2	2	2	MR-SA 102, 103	NF30 type 15a	2	2	2	MR-SA 152, 153	NF30 type 15A	2	2	2	MR-SA 202, 203	NF30 type 20A	3.5	3.5	2	MR-SA 302, 352	NF30 type 30A	5.5	5.5	2	MR-SA 502	NF50 type 50A	5.5	5.5	3.5	MR-SA 702	NF100 type 75A	8	8	3.5
Model	No-fuse breaker			Wire size mm ²						Magnetic brake																																													
		R, S, T, $\frac{1}{2}$	U, V, W	P, C	G1, G2																																																		
MR-SA 22, 32, 33	NF30 type 5A	2	2	2	1.25	1.25																																																	
MR-SA 52, 53	NF30 type 10A	2	2	2																																																			
MR-SA 102, 103	NF30 type 15a	2	2	2																																																			
MR-SA 152, 153	NF30 type 15A	2	2	2																																																			
MR-SA 202, 203	NF30 type 20A	3.5	3.5	2																																																			
MR-SA 302, 352	NF30 type 30A	5.5	5.5	2																																																			
MR-SA 502	NF50 type 50A	5.5	5.5	3.5																																																			
MR-SA 702	NF100 type 75A	8	8	3.5																																																			

Continued on the next page.

	Description
Wiring	<p>1. Note that each phase of servo amplifier output (U,V,W) Must meet that of motor input. If phase sequence does not meet, the motor may run out of control or generate intense vibration. Note that correct phase sequence cannot be achieved only by changing connection between two phases. For power source terminals (R,S,T) of servo amplifier, it is not necessary to consider phase sequence.</p> <p>2. Do not connect power source to the output terminals (U,V,W).</p> <p>3. The servo amplifier cannot be covered accidents due to leakage. Pay attention so that the cable does not touch the chassis, etc. If the overcurrent protector is repeatedly operated, it will lead to deterioration of the parts, and the transistor will be sometimes broken. If the protector is activated, securely correct the cause.</p> <p>4. Be sure to use twisted wires for connection of motor thermal protector (G1,G2). When thermal protector is not used, short-circuit terminals G1 and G2.</p> <p>5. Optional discharge resistor for regenerative brake. The regenerative option is differently connected depending on a model. Refer to Item 4-2. Any other except the exclusive unit can not be connected to the connection terminals of the regenerative option of the servo amplifier. If it is improperly wired, the amplifier will be broken. Moreover, refer to Item 4-2 for other cautionary points.</p> <p>① 0.2 or 0.3kW ... Connect the exclusive option GZG150 5kOHM between P and N.</p>

Continued on the next page.

	Description
Wiring (cont'd)	<p>② 0.5 to 5.0 kW ... Connect the exclusive option MR-RB30 or MR-RB50 between P and C. Be sure to remove the short bar from between D and P.</p> <p>③ 7.0kW Since it is standard, connect the attached MR-RB51 between P and C.</p>
Dynamic brake	<p>The dynamic brake circuit is integrated in the servo amplifier, but is sometimes impossible to use if the load inertia is large. (Special servo amplifier is necessary.) If the load inertia rate is 30 times or more for 2.0kW or less, 15 times or more for 3.0 and 3.5kW or 10 times or more for 5.0 and 7.0kW, contact your dealer or our representative.</p>
Operation sequence	<ol style="list-style-type: none"> 1. When a motor equipped with electromagnetic brake is used, motor is not released immediately after brake is energized. Therefore, operation sequence should be that motor start signal is input after brake release is completed. 2. Don't use the electromagnetic brake for deceleration except in case of emergency stop. It is allowable to use the electromagnetic brake in combination with the dynamic brake in case of emergency stop. 3. Don't use the dynamic brake very frequently, or the parts will be deteriorated.

Continued on the next page.

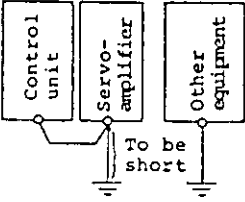
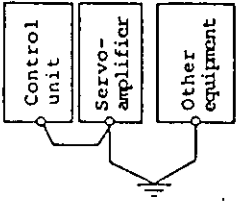
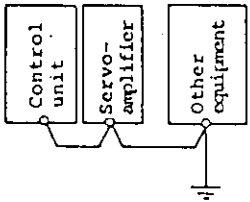
	Description
Grounding	<p>Round the system referring to the standard connection diagram in Item 4-1. Be sure to ground the servomotor together with the servo amplifier at one point. It is recommended to use an independent ground line. If a common ground line must be used, the connection should be as shown below.</p> <div style="display: flex; justify-content: space-around; align-items: flex-end;"> <div style="text-align: center;">  <p>(1) Exclusive grounding line ... BEST</p> </div> <div style="text-align: center;">  <p>(2) Common grounding line ... GOOD</p> </div> <div style="text-align: center;">  <p>(3) Common grounding line ... NOT ACCEPTABLE</p> </div> </div>

(2) Control circuit

Table 4-3 Cautions for wiring (control circuit)

	Description
Protection against noises	Control signal lines should be protected from noises properly.
Operation sequence	<p>Don't use the servo on (SON) signal for motor start/stop. Because of the capacitor input type, the highly frequent power on/off will lead to deterioration of the parts. Refer to Item 4-5. For the start/stop signal timing, refer to Item 4-5 (2).</p>

Continued on the next page.

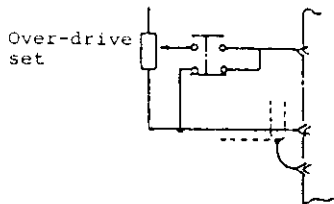
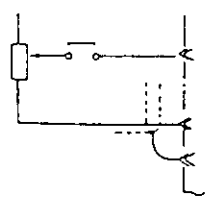
	Description
Signal circuit	<p>1. Design external analog signal circuit (circuit for over-ride set) so that it remain close at all times to protect against inductive noises.</p> <div style="display: flex; justify-content: space-around; align-items: center;"> <div style="text-align: center;">  <p>(GOOD)</p> </div> <div style="text-align: center;">  <p>(WRONG)</p> </div> </div> <p>2. For relay used to turn on and off analog and digital reference signal, select relay for faint current application (with two parallel contacts, for exmample). Open collector transistor may be used in lieu of relay.</p> <p>3. Input-terminal which uses the contact point b</p> <p>The following input signal is not operable unless the continuity is established to SG during operation. Be sure to use the contact point b of the relay.</p> <p>See the standard connection diagram in Item 4-1.</p> <p>(1) Forward/Reverse stroke end(LSP and LSW)</p> <p>(2) Proximity dog (when the manual zero return is operated in the positioning selection mode.)</p> <p>4. The permissive maximum current of interface driver power supply (VDD) is 200 mA. Note that the total current for external control unit, relay, etc. should not exceed 200 mA.</p> <p>5. Check polarity of flywheel diode used for output signal relay. If polarity is inverse, the servo amplifier may be damaged.</p> <p>6. When connecting the wires to the signal connector, suitably peel the sheath off the wire and take care to prevent the whiskers of element wire or solder from causing short-circuit.</p> <p>In the applications where the servo motor travels, take care to slacken the cable in order to prevent stress from working on the wiring (particularly on the connected area of the connector).</p>

4-7 Countermeasure against noise

If noise enters the servo amplifier, operation panel or detector from the external, it will result in malfunction which prevents generation of the required performance. It is important to prevent generation of noise. Even if noise generates, it must not be induced into the servo amplifier. When designing the operation panel and manufacturing and routing the signal cables, observe the following to take secure countermeasure against noise.

(1) Signal cable selection

If the signal cable becomes long, it works as an antenna which is liable to receive external noise. Therefore, take care to prevent the cable from being longer than specified. Moreover, use the twist pair shield cable as the signal cable. The signal cables are specified as follows:

- ① Use the twist pair shield cables as the connection cables (CN2) to the detector. The cables must be 30m or shorter.
- ② Use the twist pair shield cables as the control signal cables (CN1) to the detector. The cables must be 2m or shorter. If the length exceeds inevitably 2m, provide a low-level relay to make the relay to servo amplifier cable 2m or shorter. In case of the multi-core cable, the separate pair cable is more noise-resistant than the general shield cable.

(2) Grounding

Referring to Items 4-1 and 4-6, securely ground the system.

(3) Wiring

- ① Securely separate the signal cables from the AC100V or higher power cables when routing them (provide 20cm or wider clearance.), and don't route them in the same duct.
- ② If it is difficult to separate the signal cables from the power cables, route them with care to prevent them from running parallel.

(4) Surge killer

① Surge killer mounting

Around the amplifier, provide the surge killers on the AC relays, AC valves, AC electromagnetic brake, etc. and the diodes (Voltage resistance: 4 times or more than the drive voltage of the relay, etc. Current: Two times or more of the drive current of the relay, etc.) on the DC relays, DC valves, etc. parallel to the relays.

Figs. 4-9 and 4-10 show the mounting examples of the surge killers.

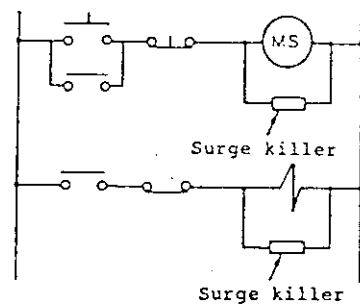

(a) Mounting on the AC relay, AC valve, etc.

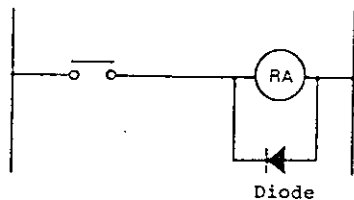

(b) Mounting on the DC relay, etc.

Fig. 4-9 Surge killer mounting diagram

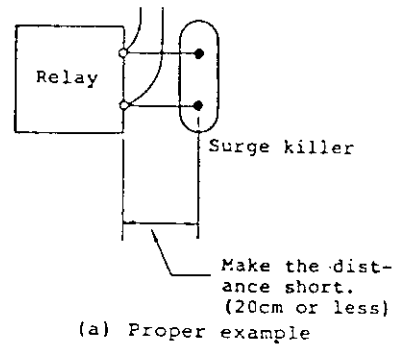

(a) Proper example

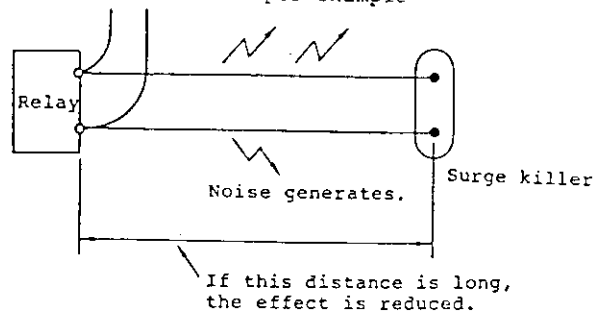

(b) Improper example

Fig. 4-10 Surge killer layout

② Attach the surge killers to be adjacent to the device (relay, etc.) which actually produces noise. As the wiring becomes longer, not only the effect becomes smaller but also the noise absorbed by the surge killer is more liable to be induced in the other signal cable. Keep in mind that the reverse effect will thus result. Refer to Fig. 4-10.

(5) Shield cable processing

As aforementioned in Item (1), the shield cables are securely used as the signal cables. However, not only the effect is reduced but also the adverse effect may result unless the shield is properly processed. Securely process the shield as follows:

① Connect the outer sheath of the shield cable to the terminal SD of the servo amplifier connector, and be sure to open the other end. Refer to Fig. 4-11 and 4-12.

[Example 1]
Normal shield

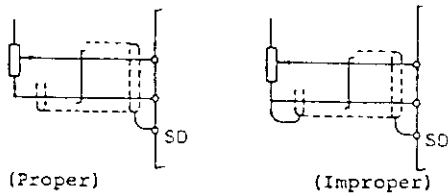

Fig. 4-11 Connection I of shield sheath

[Example 2]
Junction of shield cable

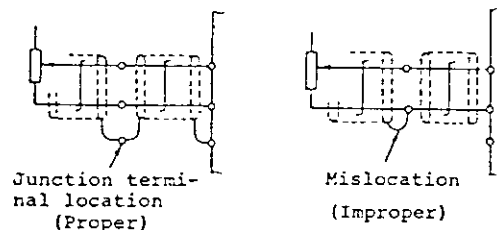
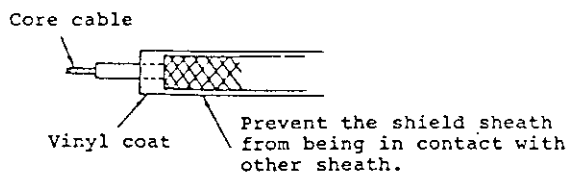
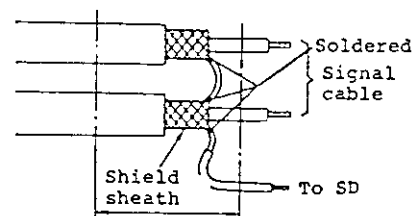

Fig. 4-12 Connection II of shield sheath

② Shield sheath processing



(a) Processing on the release side



(b) Process on the terminal SD side

Fig. 4-13 Shield sheath processing

③ Grounding the shield sheath

Though it is sufficient to connect the shield sheath to the SD terminal of the connector, the effect can be improved by directly connecting the shield sheath to the ground plate of the control panel as shown below. If the noise environment is specially poor, the ground plate connection is recommended for the cable of the motor detector.

Partially peel off the cable coat to expose the sheath, and press the peeled area against the ground plate with the cable clamp hardware. If the cables are fine, clamp several cables with the clamp.

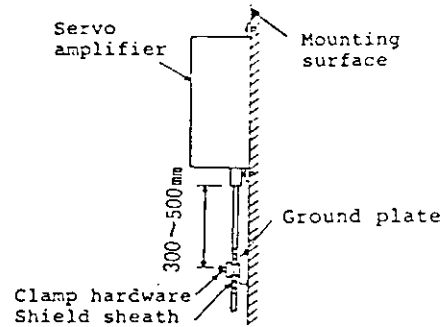
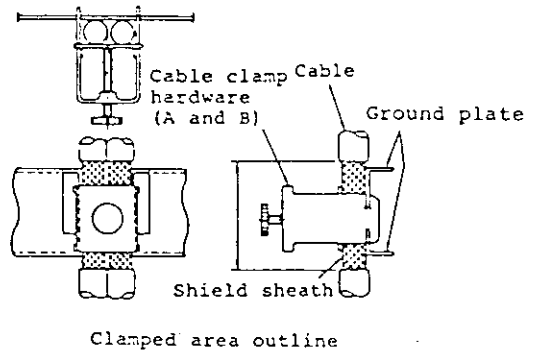

Fig. 4-14 Shield sheath connection



(6) LG terminal

Though the ordinary LG terminal is separated from the earth ground, it is sometimes effective to ground the LG terminal if it is influenced by external noise. However, keep in mind that it will take adverse effect if it is insufficiently connected to the earth ground.

(7) Enforced noise resistance

To sufficiently gain the performance specified for the servo system, take the noise resistant counter-measure referring to Items (1) thru (6) aforementioned.

If the noise influence can not be avoided, or if the signal cable can not be separated from the power cable, the signal cable must be routed through the metallic tube to shut out the noise.

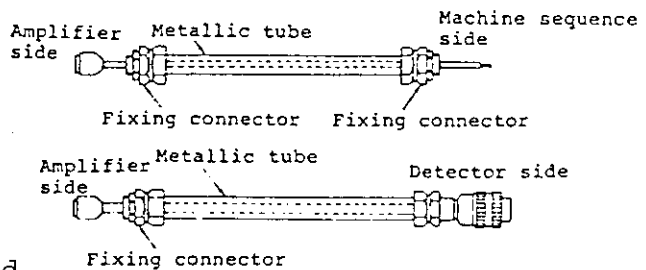

4-8 Structure of input/output terminals

(1) Servo motor

The configuration of servo motor terminal box is shown below.

Referring to the figure, connect the cable to the motor terminals correctly.

Before connection, be sure to identify each motor lead and servo amplifier output terminal for phase (U, V and W) and assure correct phase sequence.

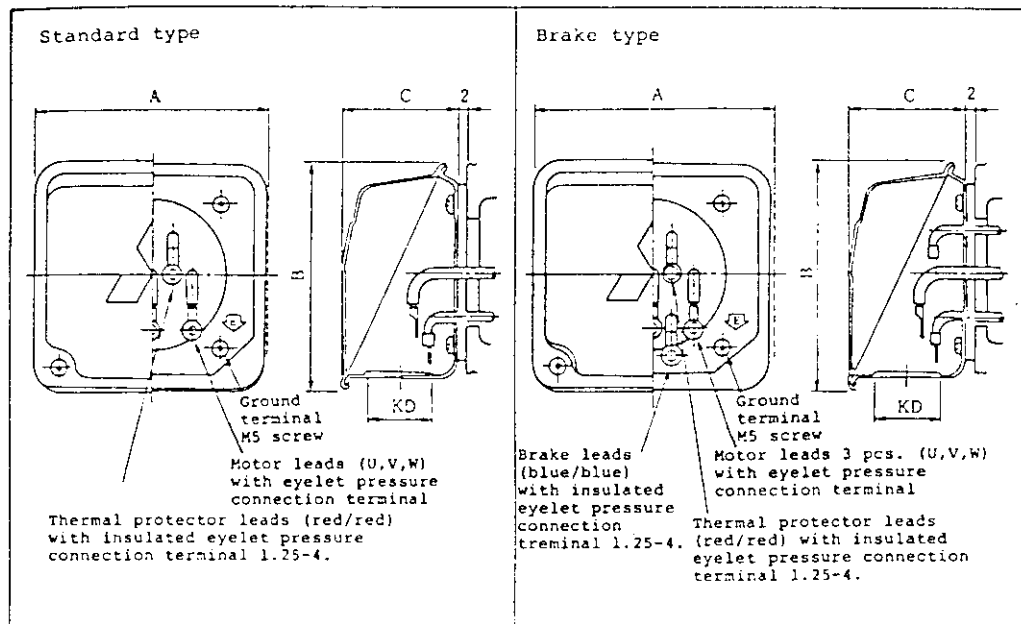
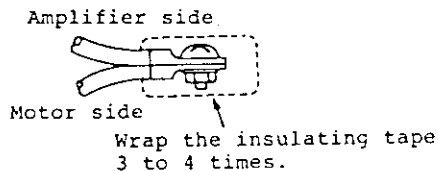



Fig. 4-15 Detail of terminal box

Table 4-4 Dimensions of motor terminal box.

Mode	A	B	C	KD	Terminal connection thread size
HA-SA52(B), 53 to HA-SA352(B)	80	78	40	22	M4
HA-SA502(B)	93	104	48	27	M6
HA-SA702(B)	131	144	78	35	M6

Note: 1. For terminal connection, use the bolts shown above and connect the terminal as shown below. Wrap insulating tape on the connected area 3 to 4 times for sufficient insulation. When storing the terminal in the terminal box, take care to prevent injuring the insulated area.



2. Be sure to connect the cable to the ground terminal  in the terminal box. Connect to the ground terminal of the servo amplifier for grounding through the ground plate in the control panel. Refer to Items 4-1 and 4-4.
3. No terminal box is provided for HA-SA22(B) and 33. The power lead cables are of a direct connection type.
4. The DC24V power supply (15W or more for 1.5kW or less motor and 25W or more for 2.0kW or more) shall be procured for the brake lead cables of the electromagnetic braked motor by the user.
The driver power supply VDD (DC24V) of the servo amplifier can not be used commonly.

(2) Servo amplifier

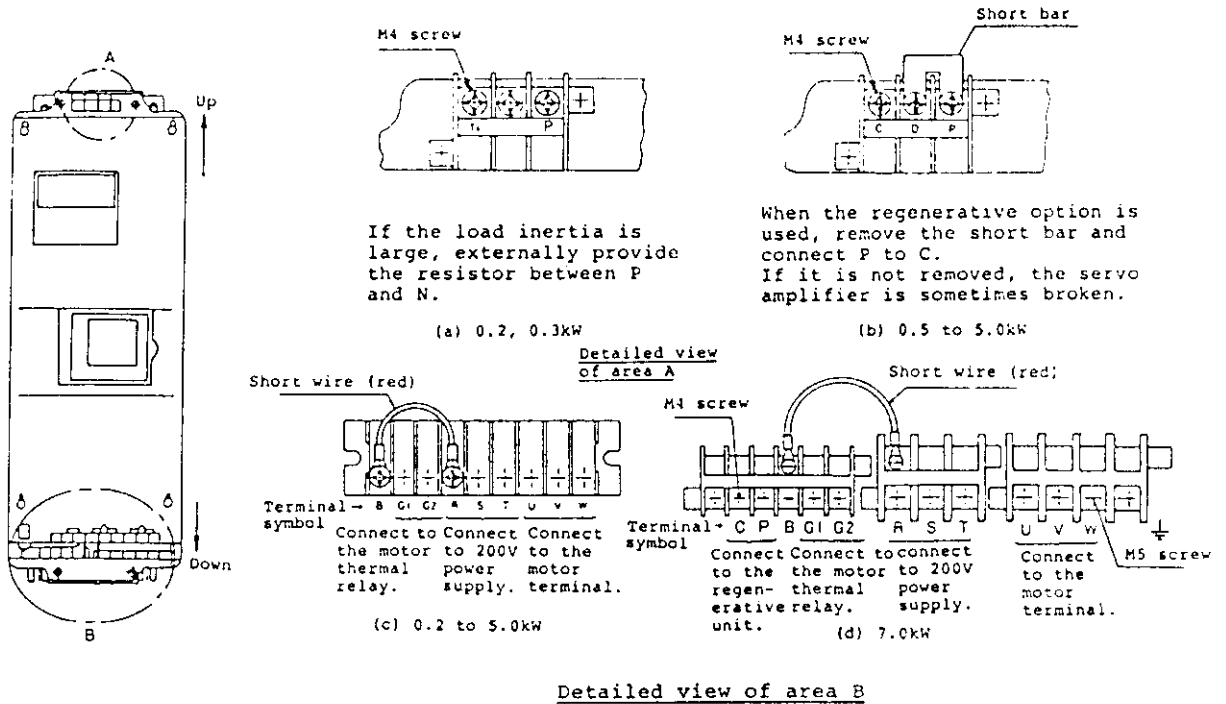

Fig. 4-16 Main circuit terminals of servo amplifier

(3) Connector pin arrangement

The connector pin arrangement, as viewed from the cable connection side, is schematically shown below. The pin Nos. are described on the upper line, and the corresponding signal names are on the lower line.

1 CN1 (Connector for general control signals)

Model: MR-50F, MR-50L HONDA

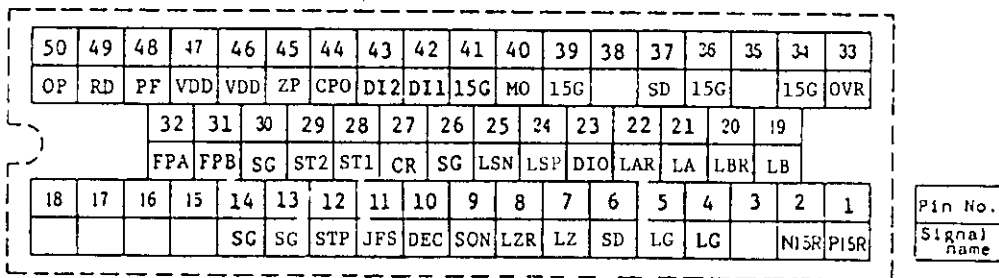

(a)

2 CN2 (PLG signal connector)

Model: MR-20M, MR-20L
HONDA

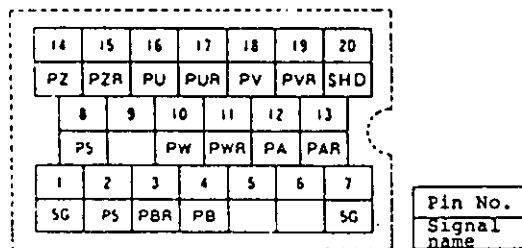

(b)

3 PLG connector: Motor side

Model: MS 3106 B 20-29S
(MS 3108 B 20-29S)

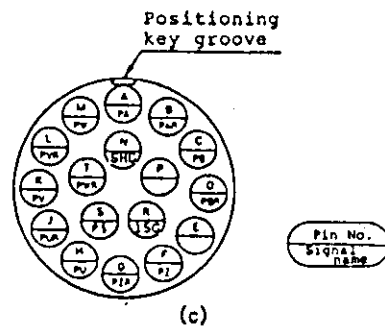

(c)

Fig. 4-17 Connector pin arrangement

5. OPERATION OF KEY SETTER

Display of state, parameter setting, diagnosis, etc. can be conducted using attached key setter (MR-SU) and indicator (MR-DP6).

Display and operation of key setter and meaning of parameters are explained hereunder.

5-1 Display description

Sequence in the following flow chart will be displayed on the indicator. Any desired step in the sequence can be selected by the key setter.

Reference for respective displays are as listed below.

1. Command monitor Section 10-1 Table 10-1
2. Servo monitor Section 10-1 Table 10-1
3. Diagnosis Section 10-2 Table 10-2
4. Alarm history Section 10-3 Table 10-3
5. Stored data Section 10-4 Table 10-4, 5
6. User parameter Section 10-4 Table 10-4, 5
7. Special parameter Section 10-4 Table 10-6

5-2 Operation of key setter (MR-SU)

Key setter (MR-SU) and (MR-DP6) are used to set various parameters and to display states and alarms related to servo.

(1) Composition

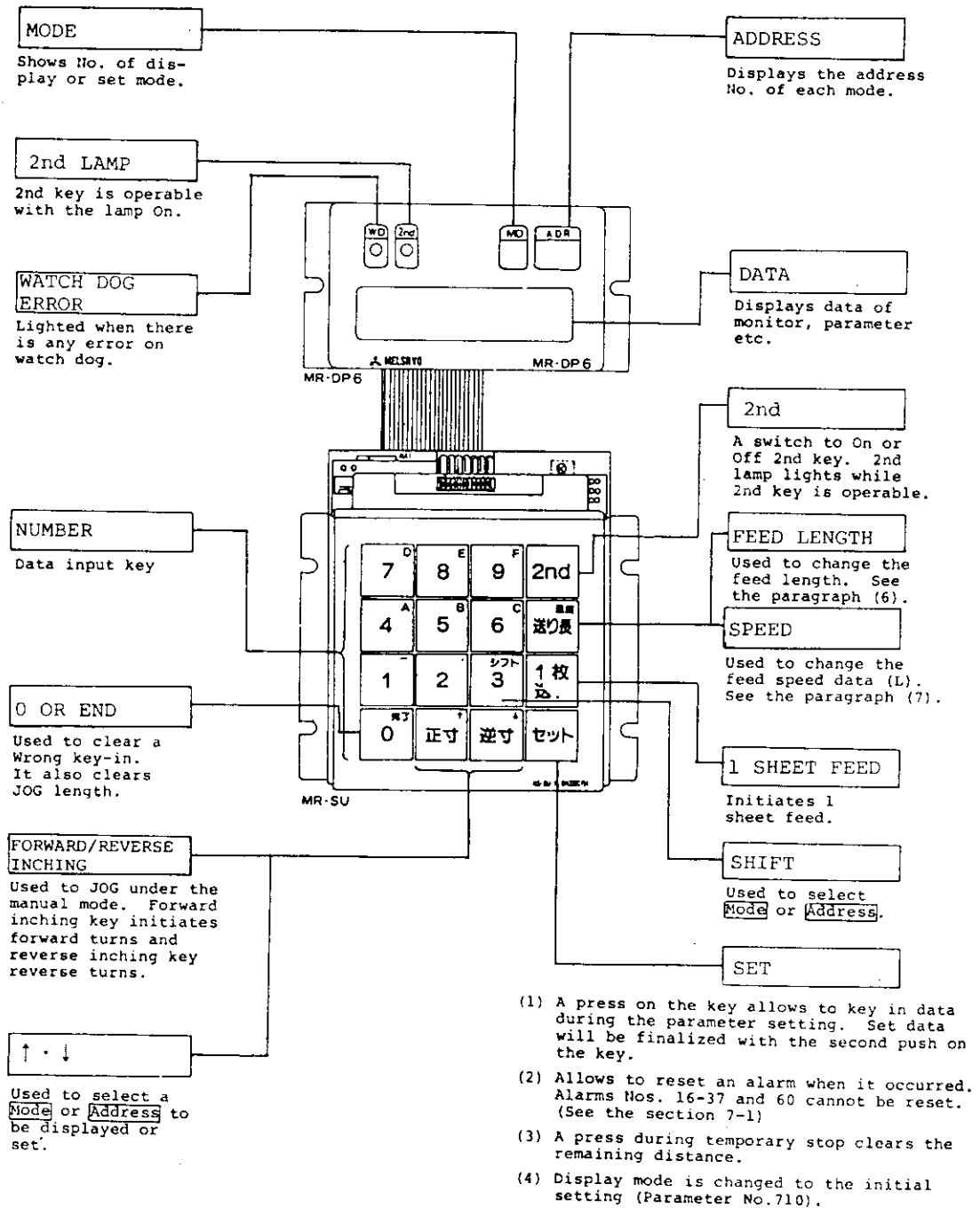

Fig. 5-2 Operational functions of key setter

(2) Functions

Following features can be controlled with the key setter and the indicator.

- ① State display (Command monitor, servo monitor)
- ② Diagnosis of On or Off of external signal, setting of operation mode, etc.
- ③ Display of present alarm or alarm history
- ④ Setting, display of user parameters
- ⑤ Reference to special and maintenance parameters
- ⑥ Feed length data (Parameter No.602) key in during operation (Data becomes effective at the next operation after stop.
- ⑦ Feed speed data (Parameter No.611) key in during operation (Data becomes effective at the next operation after stop.

(3) Key lock function

Dip switches SW5-1, 2 are provided to limit the content of display or setting. They are useful to protect the set value of parameter, etc. from erroneous operation of key setter. It is recommended to turn on SW5-1, 2 at the shipment from factory. When setting of these switches has been changed, the power shall be turned off and backed on. See Fig. 5-1.

(4) Interpretation of displays

Please refer to Section 5-1 and Chapter 10 for detailed explanation of displays.

① Power on

At the power on, a sequence of diagnosis mode will be displayed for about 1 second. When SON signal is Off, it will show

r	d	-	o	f	f
---	---	---	---	---	---

 or, when the signal is On,

r	d	o	n
---	---	---	---

. About 1 second later, the display will be replaced with the last location on display (which was adjusted at just before the power was turned off).

② Transition in the content of display

Under the initial state (at shipment from factory), when the power is turned on, it will display the present position under the command monitor mode.

a. To change the display under command monitor mode

I) Conform that the decimal point at ADR display is lighted. When the point at MD display is lighted, transfer the point at ADR by hitting **Shift** key. **Shift** key is dead unless 2nd lamp is lighted. Hit **2nd** key when the lamp is not lighted.

II) If **↑** key is hit, the display on MDR will change orderly from **1.01** → **1.02** → → **1.05** → **1.01** → and corresponding contents will appear in the same order on DATA section.

↓ key is used to reverse the order of progress.

b. To change the display mode

I) Confirm that the decimal point is lighted at MD display. Transfer the point with **Shift** key when it is lighted at ADR display.

II) If **↑** key is hit, the display on MD and ADR will change orderly from **1.01** → **2.01** → **6.01** → **1.01** → along with the display of corresponding contents on DATA section. **↓** key will reverse the order of change.

III) To choose any content, adjust the display mode first as explained above and then transfer the position of display as described in the paragraph a.

Note: Please remember the limit of transfer at MD section is restricted with the setting of SW-5-1, 2 in the servo amplifier. Refer to the paragraph (3).

(5) To set parameters

Parameter data can be changed even during operation. To reflect the change on the operation, you have to stop the motor once (after the end of command). Sequence of operation and example of setting are shown below. It is necessary to turn the power off and back on again before parameters Nos. 601, 604, 605 and 701 becomes effective. See Section 10-4, Table 10-4.

- I. Set a desired parameter data position on MD or ADR as described in the paragraph (4).
- II. Press **Set** key to enable the writing of data. Flickers in MD, ADR displays show the data can be input.
- III. Input a desired number on the data section.
- IV. Press again **Set** key to complete the data input.

[Example of setting]

Steps to set parameters Nos. 604 and 605 (Electron gear numerator, denominator) at CMX=1400, CDV=7854 respectively.

- ① Be sure that SW5-1, 2 of servo amplifier are at Off and the key lock is released.
- ② Confirm that the decimal point of MD display is lighted. If not, check if **2nd** lamp is lighted (press 2nd key when the lamp is dead) and then hit **Shift** key. Now the decimal point at MD display will be lighted.
- ③ Use **↑** or **↓** key to show 6 on MD display.
- ④ Press **Shift** key to light the decimal point at ADR display and then recall the parameter No.604 using **↑** or **↓** key.

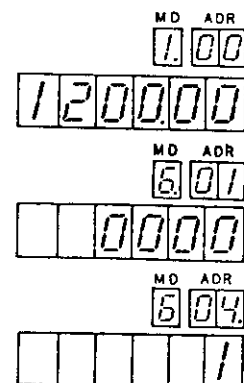

⑤ Press 2nd key to turn off 2nd lamp.
If you hit Set key here, MD and ADR displays will flicker and prompt to input the data.

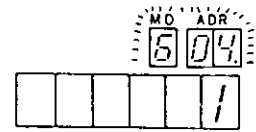

⑥ Hit the key in order of 1 4 0 0 Set and the data input is over.

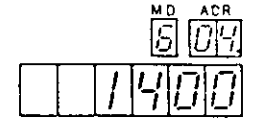

⑦ Light 2nd lamp by hitting 2nd key and then recall the parameter No.605 with ↑ key. Hit again 2nd key to turn off the lamp and input the data in order of Set 7 8 5 4 Set to finish the writing.

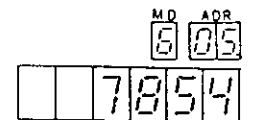

⑧ If you turn Off the power and back on again, these data become effective.

[Reference]

When the data input is over, turn on SW5-1, 2 switches of servo amplifier and turn off/on the power. This will lock the keys and troubles by operation error will be avoided. See the paragraph (3).

(6) To set the feed length

The following method allows to change the parameter No.602 (feed length) not using the normal parameter set steps as described in the paragraph (5) and even if keys are locked. This method can be utilized effectively when it is necessary to change the setting during operation.

[Example of setting]

To change the feed length from 120.00 mm to 80.00 mm..

① If you press Feed length key, the display will jump to the parameter No.602. 2nd lamp must be dead at this moment. If it is on, hit 2nd key to turn off the lamp.

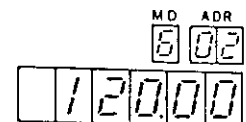

6. OPERATION PROCEDURE

6-1 Initialization

It is necessary to confirm the state of parameter before starting operation.

Although each parameter has its own initial value, be sure to check the content before starting operation and, if necessary conduct the initial setting depending on the purpose of operation.

The following parameters require special attention and therefore you must confirm before operation. Regarding other parameters, please refer to Section 10-4. It is necessary to confirm the content also on these parameters before operation.

(1) Feeding method OP1 (Parameter No.601)

Initial setting is made with the roll feed type and the increment display. When the positioning type is used or the regenerative option is used, it is necessary to change the parameter setting based on the user parameter set data of Table 10-5. See the following table.

① Selection of feeding method (1st and 4th digits, bit 0, 1, 2, C)

Set the data based on the following table.

Table 6-1 Relation between the feeding method and bit data of parameter No.601

Feeding method	Command method (Cordinate system)	Feed length set method	Parameter No.601 bit				(Note) Display of parameter No.601 5.0 kW or less/7.0 kW
			4th digit from right	Rightmost digit			
			C	2	1	0	
Roll feed	Increment	Parameter set (1 point)	0	0	1	1	0003/0203 (Initial setting)
		Digital switch	1	0	1	1	1003/1203
Positioning	Increment	Parameter set (1 point)	0	0	1	0	0002/0202
		Digital switch	1	0	1	0	1002/1202
		Parameter set (1 point)	0	0	0	0	0000/0200
	Absolute	Digital switch	1	0	0	0	1000/1200
		Stored data (Max. 16 points)	0	1	0	0	0004/0204

Note: Data in the table are applicable to when the direction of revolution, over-ride setting and regenerative option setting are of the initial setting. When the regenerative option is used, 2nd and 3rd digits of data must be changed based on Section 10-4 and Table 10-5.

Models of 7.0 kW has a unit MR-RB51 and the 3rd digit is preset with 2. (See the paragraph 3))

② Direction of motor revolution, over-ride (2nd digit from right of data, bit 4, 6)

Under the initial setting,

I) Motor turns in the direction of CCW with the forward start (Present position count up) or in CW direction with the reverse start (Present position count down).

II) Over-ride is inoperable.

To change the direction of motor revolution and to turn the over-ride to be operable, it is necessary to change the data based on the following table.

Table 6-2 Relation between the direction of motor revolution, over-ride On and the parameter No.601

Direction of motor revolutions	Over-ride	Parameter No.601 bit		2nd digit from right of parameter No.601
		2nd digit from right		
		6	4	
CCW turn with forward start	Ineffective	0	0	0 (Initial setting)
	Effective	1	0	4
CW turn with reverse start	Ineffective	0	1	1
	Effective	1	1	5

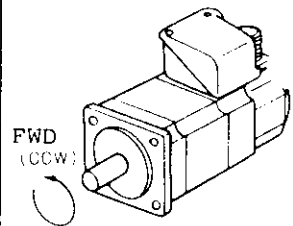

Example: When the over-ride is turned on with the roll feed parameter setting, the setting of parameter No.601 will be 0043.

③ Selection of regenerative option (3rd digit from right of data, bit 8, 9)

The initial setting has not the regenerative option. When the option is used, the setting must be changed. False setting will raise the alarm and damages.

Table 6-3 Relation between the regenerative option and the parameter No.601

Regenerative option		Parameter No.601 bit		3rd digit from right of parameter No.601
		3rd digit from right		
		9	8	
0.5 to 5.0 kW	None	0	0	0 (Initial setting)
	MR-RB30	0	1	1
	MR-RB50	1	0	2
7.0 kW	MR-RB51	1	0	2

Example: When the absolute command of positioning method and the stored data transmission are combined with the regenerative option MR-RB50, the parameter No.601 will be 0204. Since the models of 7.0 kW have MR-RB51, it must be 2. In case of 0.2, 0.3 kW models, it must be 0 even when a dedicated option is installed.

[Reference] Feeding method and coordinate

There are following relations between the methods of feeding and command and the present value on the indicator or JOG length and the position on counter assembly in servo amplifier.

Table 6-4 Relations between feeding method and coordinate

Feed method	Command method (Coordinate)	Zero point (0 on coordinate)	Position data set range (Note 1, 2)	Movable range with auto start	(Note 4) Movable range with JOG operation
Roll feed	Increment	Start position	+0 to +999999	+0 to +999999	—
Positioning	Increment	Mechanical zero with dog type zero return	+0 to +999999	(Note 3) -1999999 to +1999999	-1999999 to +1999999
	Absolute		+0 to +999999	+0 to +999999	
Positioning at stored data	Absolute		-999999 to +999999	-999999 to +999999	

- Note:
1. Unit of feed length is determined by the setting of parameter No.603.
 2. Direction of CCW or CW of motor revolutions with the position count up can be determined by the setting of parameter No.601.
 3. Under the increment positioning mode, the position counts down with the reverse start.
 4. Auto zero return is effective when it is within the movable range of JOG operation. Beyond this range, it cannot return to the normal position or it may run wildly. It is necessary to provide the stroke end LS for protection.
 5. MR-DP6 has a 6 figures display so that when the count goes beyond ± 999999 , it starts again from 0.

- (2) Feed length STX (parameter No.602) and feed length magnifying ratio STM (parameter No.603)

Feed length per each positioning or absolute position can be set with STX and STM. When the feed length is set using the external digital switch, STX is set to 0. This may not be 0 so far as the digital switch is set to be operable with the setting of parameter No.601. Please remember that the actual travel (mm) and the set feed length will not be the same when the electron gear CMX, CDV are not set correctly.

- (3) Electron gear CMX, CDV (parameter Nos. 604, 605)

It is expressed with number of pulses (1200) per each motor turn as a numerator and the mechanical travel (μm) per each motor turn as a denominator. Take CMX as a numerator and CDV a denominator and set them within 1 - 9999 so that the ratio will be 1/20 - 1/50. See Table 10-5.

(4) Servo gain PGN, VGN, VIC (parameter Nos. 606, 607, 608)

They are set depending on the inertia of load. Guideline of setting is shown by Table 10-4 but it may not need to change the initial setting so far as there is no troubles (abnormal vibrations of motor, hunting, etc.) It should be remembered the load conditions may not be the same at the test run and the normal operation under actual load. Regarding detailed setting method for normal operation, refer to Section 6-4.

(5) Time constants of acceleration/deceleration and time to change time constant (parameter Nos. 613, 614, 615)

For the normal linear acceleration or deceleration, use T1A and set T1B = 9999, T1T = 0 (initial value). T1A, T1B, T1T shall be set separately when it is operated with pseudo S time acceleration or deceleration. When the effective shockless acceleration or deceleration is desirable, the guideline is T1T > 50 ms. It is impossible to set different time constants or to change times for acceleration and deceleration.

6-2 Precautions before operation

(1) Power on

Turn off the power (3-phase, 200V) with SON signal Off. Now the control power supply is established and the display will read fast `rd-oFF` and then the state. When the position display was changed previously, that position will be displayed.

(2) Parameter setting

Operation parameters are set at the initial values shown in Table 10-5 at shipment from factory.

Conduct the initial setting of parameters depending on the conditions of any specific operation. Before starting operation, items described in Section 6-1 must be confirmed without fail.

(3) SON signal input

When parameters are set, input SON signal.

With SON signal, a contactor installed in servo amplifier is tripped and simultaneously the dynamic brake circuit is opened to ready operation.

(4) Stroke end LS signal

Stroke end LS terminal (LSP, LSN) shall be always short-circuited with common (SG) during operation. It will not move toward the open side. Direction of motor turns can be changed with parameter No.601.

(5) Proximity dog

When the operation is conducted under the positioning mode, the proximity dog terminal (DEC) must be short-circuited with common (SG) before the power is turned on. If it is open, the zero return will be prohibited. Under the roll feed mode, DEC terminal passes the restart signal so that it is normally left open.

6-3 Operation

Release a command of slow speed operation in order to check the direction of turn, abnormal noises or vibrations of the motor. Direction of motor turn can be changed with parameter No.601. When there is any error or alarm, take steps for restoration with reference to Section 7-1. Sequences of operation under several operation modes are described hereunder.

6-3-1 Roll feed mode operation



(1) Confirmation of parameter

Confirm that the feeding method (parameter No.601) is set correctly.

Rightmost figure will be always 3 , for example 0003 .
Regarding other figures, please refer to Section 6-1 for necessary changes in such case when the regenerative option is applied.

(2) Manual mode operation

Turn on the manual mode select signal (D11). Both auto mode select signal (D10) and manual remote select signal (D12) must be turned off.

Operation mode select signal		D10	D11	D12
		OFF	ON	OFF
Start signal	Forward inching	Forward JOG		
	Reverse inching	Reverse JOG		
	1 sheet feed	1 sheet feed		

- a. If Forward inching or Reverse inching key of key setter (MR-SU) is pressed, the motor will turn while the key is held down. When the forward inching key is hit, the motor turns in the direction specified by the setting of parameter No.601 if the bit 4 is set at 0, it turns forward (CCW) or in reverse (CW) with bit 4 at 1. It is set for the forward revolution at shipment from factory. When the reverse inching key is hit, it will turn in the reverse direction. Number of motor revolutions is controlled either with parameter No.609 or 610. When the high speed (H) select signal (JFS) is turned off, it takes the speed set with parameter No.609 or, when the signal is turned on, the speed is determined with parameter No.610.

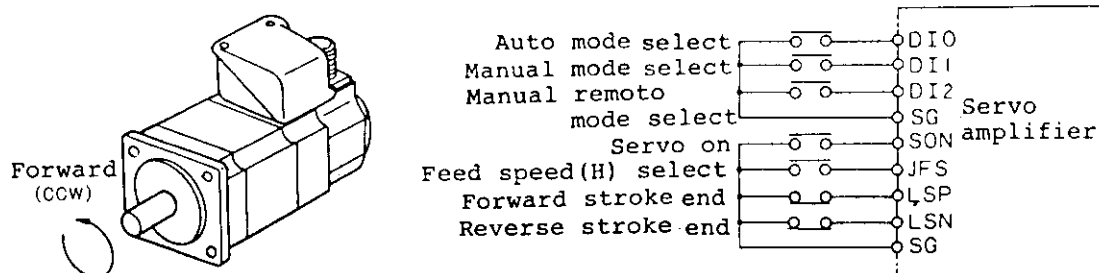

- b. If 1 sheet feed key of key setter is hit, the motor turns for the feed length which has been set with parameter No.602 or the digital switch. Direction of revolution is same as when Forward inching key was hit and the speed of revolution is determined by parameter No.609 or 610.

Temporary stop (STP) is effective and, when the restart signal (DEC) is turned On, it will feed over the remaining distance. If 1 sheet feed key is hit again after a temporary stop, the remaining distance is reset and it will feed again over the set length.

(3) Manual remote operation

Turn on both manual mode select signal (DI1) and manual remote select signal (DI2). Leave auto mode select signal (DI0) at off. If for-

Operation mode select signal		DI0	DI1	DI2
		OFF	ON	ON
Start signal	ST 1	Forward JOG		
	ST 2	Reverse JOG		

ward JOG signal (ST1) or reverse JOG signal (ST2) is turned on, the motor will turn while it is on. Direction of turn is the same as that of forward or reverse inching by the key setter but ST1 signal and Forward inching produce the same effect. Speed of motor revolutions is determined by parameter Nos. 609 and 610.

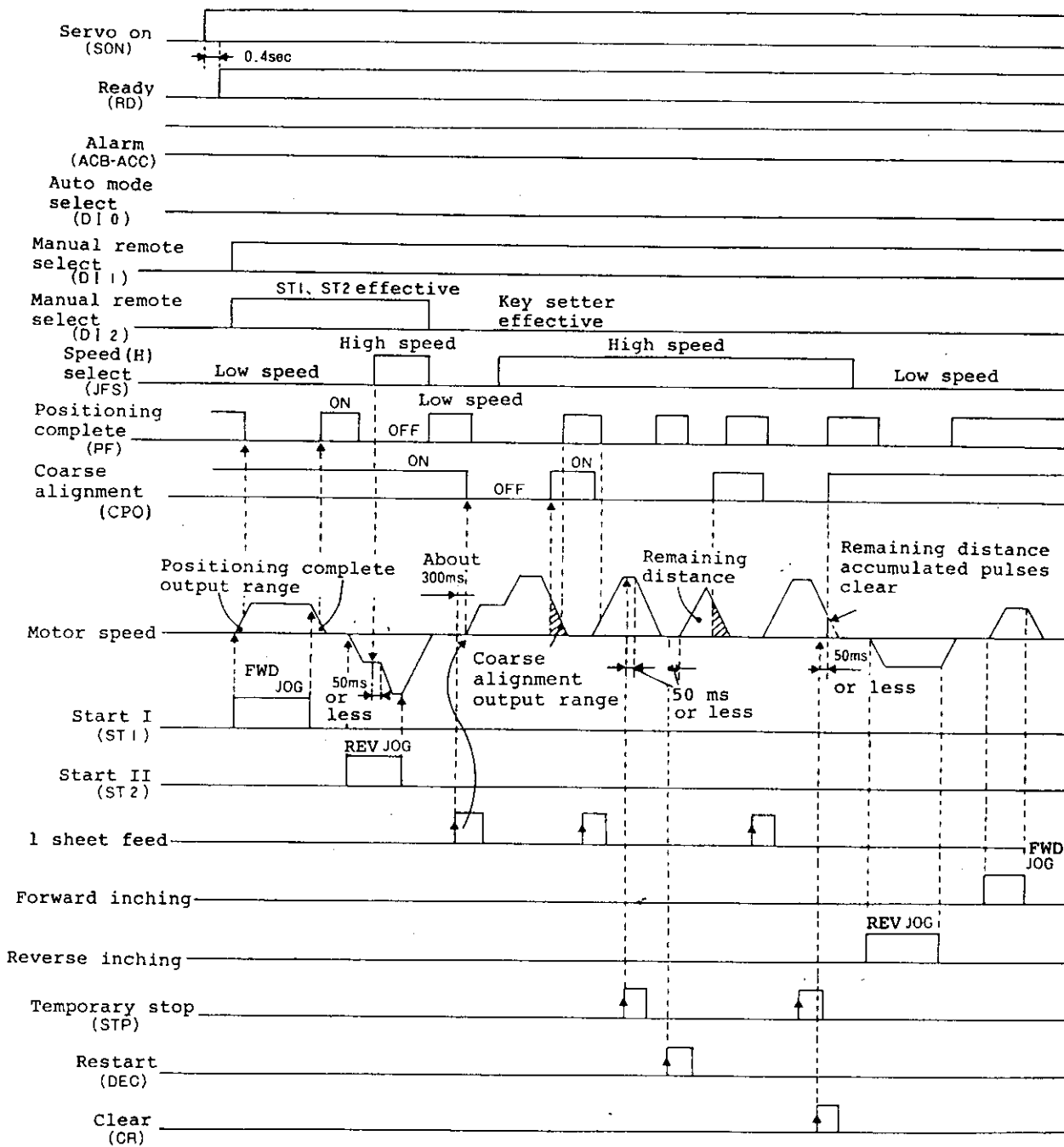

Fig. 6-1 Time chart of roll feed mode, manual mode operations

Note: 1. Coarse alignment output will be turned off after start during 1 sheet feed operation only.



2. If the restart signal key is hit, it will feed over the remaining distance. If 1 sheet feed is hit, the remaining distance is cleared and it will feed from the start of set distance.

3. During the temporary stop, commands from Forward inching / Reverse inching or ST1/ST2 can be accepted.

4. If operation mode select signals (DI0, DI1, DI2) are switched during operation, it will slow down and stop.

(4) Auto mode operation

Turn on the auto mode select signal (DI0). Both manual mode select signal (DI1) and manual remote select signal (DI2) shall be left at off.

Operation mode select signal		DI0	DI1	DI2
		ON	OFF	OFF
Start signal	ST1	Start		
	STP	Temporary stop		
	DEC	Restart		

If auto start signal (ST1) is turned on, the motor turns for the feed length which has been set with parameter No.602 or the digital switch. Direction of motor revolutions is either forward (CCW) with bit 4 at 0 in parameter No.601 or reverse with the bit at 1. It is set for the forward revolution at shipment from factory. Temporary stop signal (STP) is effective and, when restart signal (DEC) is turned on, it will feed over the remaining distance. When ST1 is turned on, the remaining distance is reset and it will feed from the start of set feed length.

Speed of motor revolutions is determined by parameter Nos. 611, 612 and it can be switched with high speed (H) select signal (JFS).

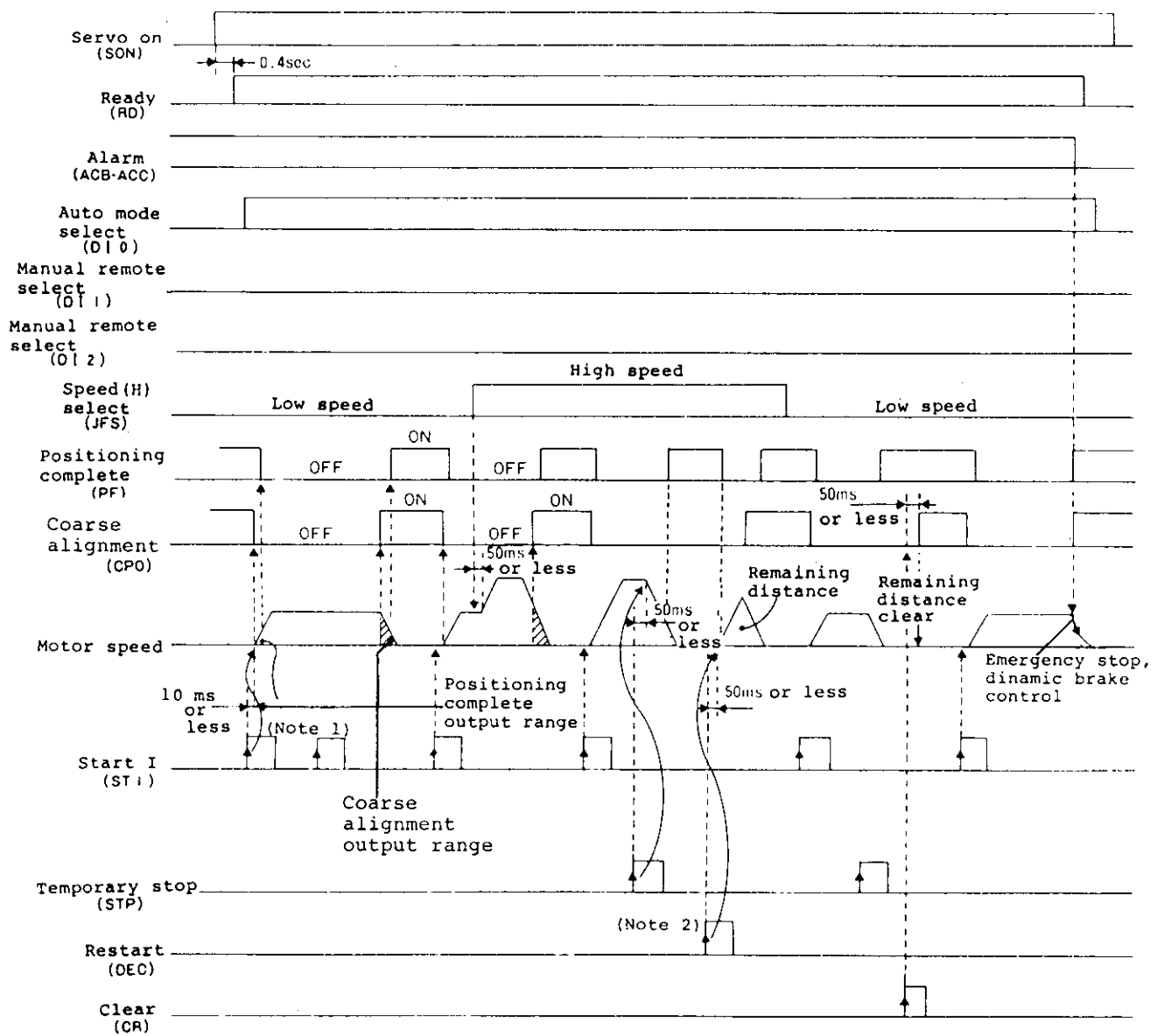

Fig. 6-2 Time chart of roll feed mode, auto mode operations

- Note: 1. Start signal during operation will be neglected.
2. If the restart signal key is pressed, it will feed over the remaining distance. When the start 1 is pressed, the remaining distance is cleared and it will feed from the start of set distance.

6-3-2 Positioning mode operation

Under this mode, the manual zero return must be done when the power is turned on. If this is neglected, it will be reminded with alarm. Manual mode operation can be conducted.





(1) Parameter setting

Confirm that the feed method (parameter No.601) is set correctly.

Rightmost digit is set at 0 or 2 like $\boxed{0}\boxed{0}\boxed{0}\boxed{0}$ for increment or $\boxed{0}\boxed{0}\boxed{0}\boxed{2}$ for absolute. Any other digit shall be reviewed with reference to Section 6-1 when the regenerative option is applied.

(2) Zero return

When the power is turned on, it is necessary for the first time to set the coordinate by executing the manual zero return (dog method). From the second, you can conduct the zero return with mechanical zero return or No.2 zero return.

Operation mode select signal		Auto zero return (High speed)			Manual zero return (Dog method)		
		DI0	DI1	DI2	DI0	DI1	DI2
		ON	OFF	ON	OFF	ON	ON
Start signal	ST1	Mechanical zero return 			Mechanical zero return 		
	ST2	No.2 zero return 			—		
	STP	Temporary stop 			Temporary stop 		

a. Manual zero return (1st after the power on)

Turn on both zero return signal (DI2) and manual mode select signal (DI1). Leave auto mode select signal (DI0) at Off. If ST1 signal is turned on, mechanical zero return by dog method will be conducted. If it is necessary to set the mechanical zero at a different

point from electrical zero point (position of Z phase signal of encoder), a zero shift amount must be set in parameter No.610.

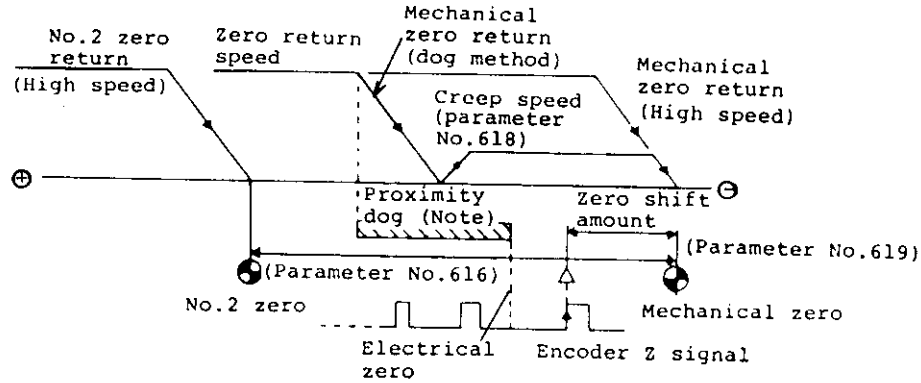

Note: Terminal of proximity dog shall be set at the center of Z phase signal.

Fig. 6-3 Method of zero return

[Caution] If the manual zero return is tried at the power on when the machine is at \ominus position, it will run wildly toward \ominus . In order to avoid accident, zero return must be conducted only after it is confirmed that the machine is at \oplus side (use JOG operation to move from \ominus to \oplus). It should be protected further by providing a stroke end LS.

b. Auto zero return

If you have conducted manual zero return (dog method) once after the power on, auto zero return (high speed) will become effective.



Turn on both auto mode select signal (DI1) and zero return signal (DI2). Leave manual mode select signal (DI1) at Off. If ST1 signal is turned on, it will move to the mechanical zero point with the high speed zero return. If ST2 is turned on, it will move to No.2 zero which has been set with parameter No.616 with high speed zero return.

c. Alarm

- I) If you try the automatic operation at the power on while manual zero return has not been completed, it will cause the alarm AL 00 - 0 .
When this occurred, you must conduct manual zero return. Alarm display can be cleared by hitting Set key of key setter after zero return has been completed.
- II) If the proximity dog is so short that it passes over the dog before slow down and stop, it will cause alarm AL 00 60 . It is necessary to secure a sufficient distance to allow the slow down and stop after it passed the dog.
- III) The same alarm will be raised also when a too short proximity dog disables to detect Z phase before the dog is turned off.
- IV) It will cause AL 00 - 0 alarm if manual zero return is tried on the dog. In such a case, move it to (+) side with JOG operation to release the dog before you retry.

(3) Manual mode operation

Turn on manual mode select signal (DI1).
Leave both auto mode select signal

Operation mode select signal		DI0	DI1	DI2
		OFF	ON	OFF
Start signal	ST1 / Forward inching	Forward JOG 		
	ST2 / Reverse inching	Reverse JOG 		

(DI0) and zero return signal (DI2) at Off.

- a. If either forward JOG signal (ST1) or reverse JOG signal (ST2) is turned on, the motor will run while the signal is kept on.
Direction of motor revolutions will vary depending on setting of bit 4 of parameter No.601. If the bit is set

at 0, it will turn in forward direction (CCW) with ST1 signal On or in reverse direction with ST2 On. Directions will be reversed if the bit is set at 1. Speed of revolutions will be determined by settings of parameter No.609 and 610 and it can be switched with high speed (H) select signal (JFS).





- b. When Forward inching or Reverse inching key of key setter (MR-SU) is pressed, the motor will run while the key is held down. Direction and speed of motor revolutions are the same as it is with ST1 and ST2 (See a. on the above) and Forward inching key and ST1 signal have the same effect.

(4) Auto mode operation

Turn on auto mode select signal (DI0). Leave both manual mode select signal (DI1) and zero return signal (DI2) at Off.

- a. Increment method

If forward start signal (ST1) is turned on, the motor will run for the distance set with parameter No.602 or the digital switch.

Operation mode select signal		DI0	DI1	DI2
		ON	OFF	OFF
		Increment		Absolute
Start signal	ST1	Forward start 	Start 	
	ST2	Reverse start 		—
	STP	Temporary stop 		Temporary stop 

Direction of motor

revolutions will be forward (CCW) when the bit 4 of parameter No.601 is set at 0 or reverse (CW) when the bit is set at 1. It is preset for the forward revolution at shipment from factory. Display of present value will be accumulated along with the amount of feed and, when it passes 999999, it will start from 0 again. Please remember that auto zero return is disabled when the movement exceeds ±1,999,999 because the internal counter overflows. Temporary stop signal (STP) is

effective and it is necessary to turn on again ST1 (or ST2 for reverse) to feed over the remaining distance. Speed of motor revolutions is determined by the set value in parameter No.612 and can be switched with high speed (H) select signal (JFS). If reverse start signal (ST2) is turned on, it will turn in the other direction than ST1.

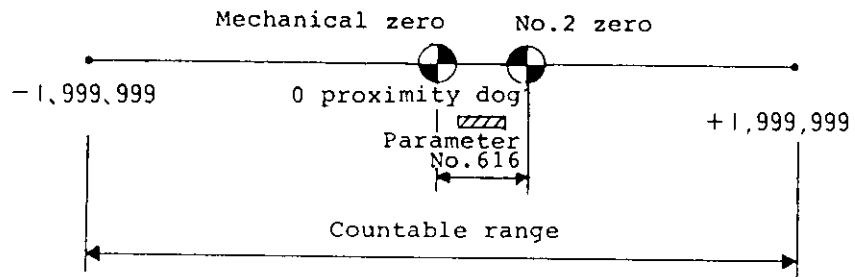

b. Absolute method

If auto start signal (ST1) is turned on, the motor will turn to the position set by parameter No.602 or the digital switch. ST2 signal will be disregarded at this occasion.

Direction and speed of motor revolutions and the temporary stop will be the same as the case of increment method.

Range of movement is within 0 to +999,999.

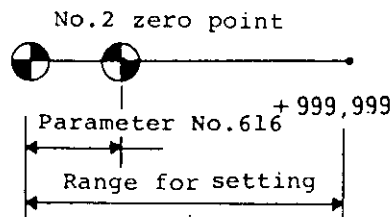

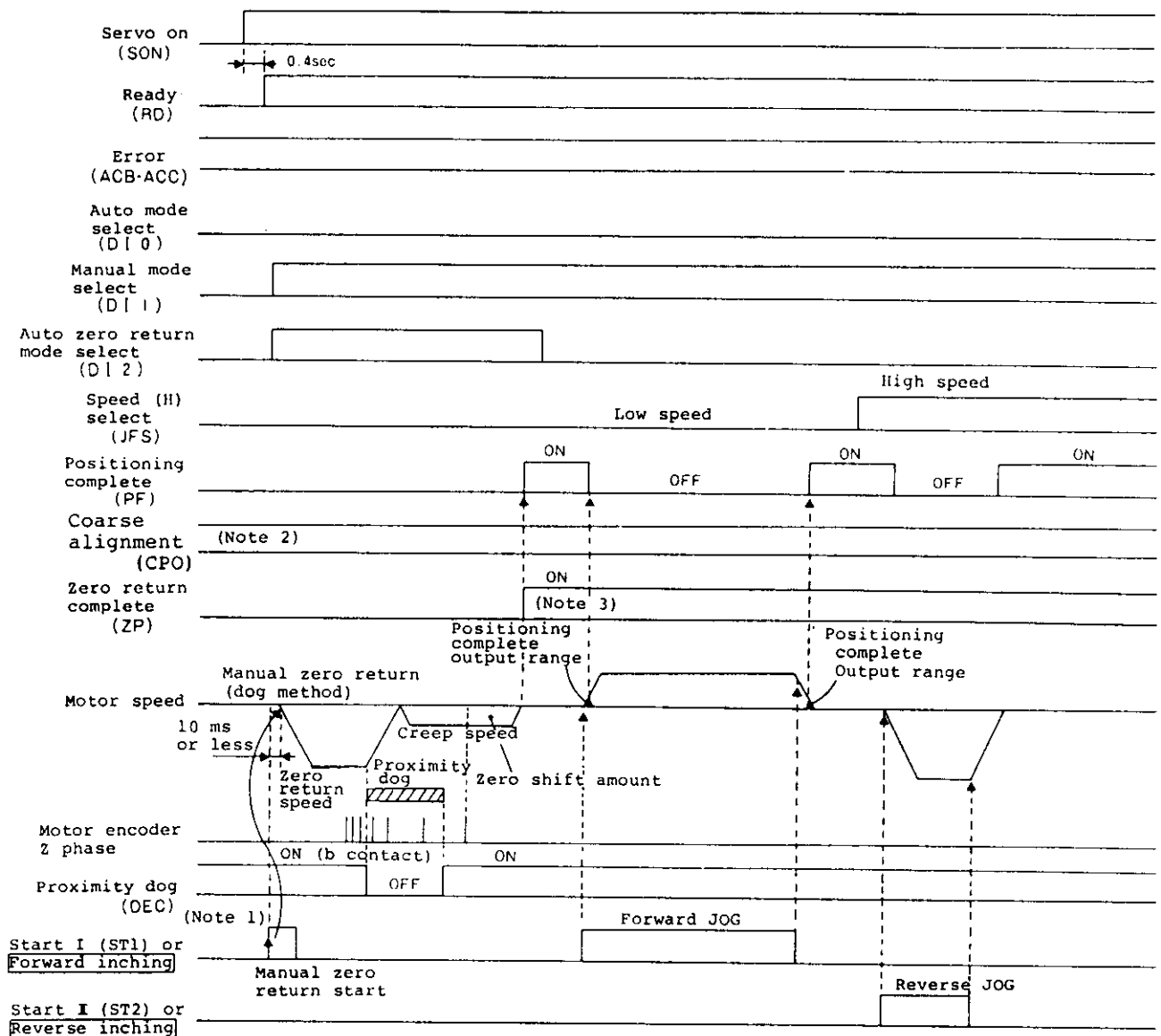

Fig. 6-4 Time chart of positioning, manual mode operations

- Note 1. Only ST1 is effective for manual zero return start.
2. During manual mode operation, the coarse alignment output is left at On.
3. Zero return complete signal is turned on at the completion of 1st manual zero return after the power on and is left at on thereafter.
4. If operation mode select signals (D10, D11, D12) are switched during manual operation, it will slow down and stop. If it occurs during zero return, the process will be continued till it is completed.

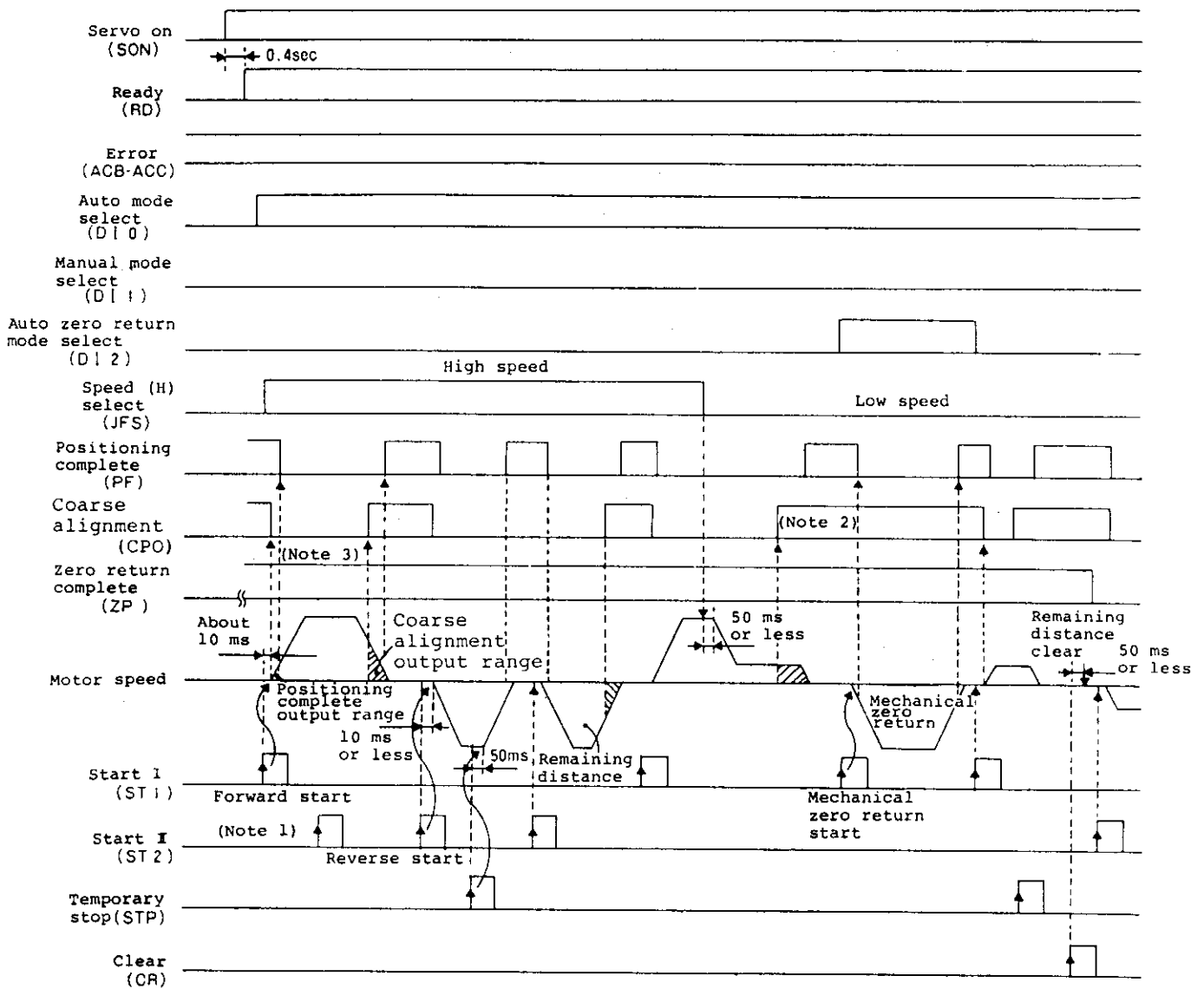

Fig. 6-5 Time chart of increment positioning, auto mode operations
(Motions following the completion of manual zero return after the power on)

- Note 1. Start signal will be disregarded during operation.
- 2. Coarse alignment will be left at On during zero return.
- 3. Zero return complete signal will be left at On after completion of manual zero return.

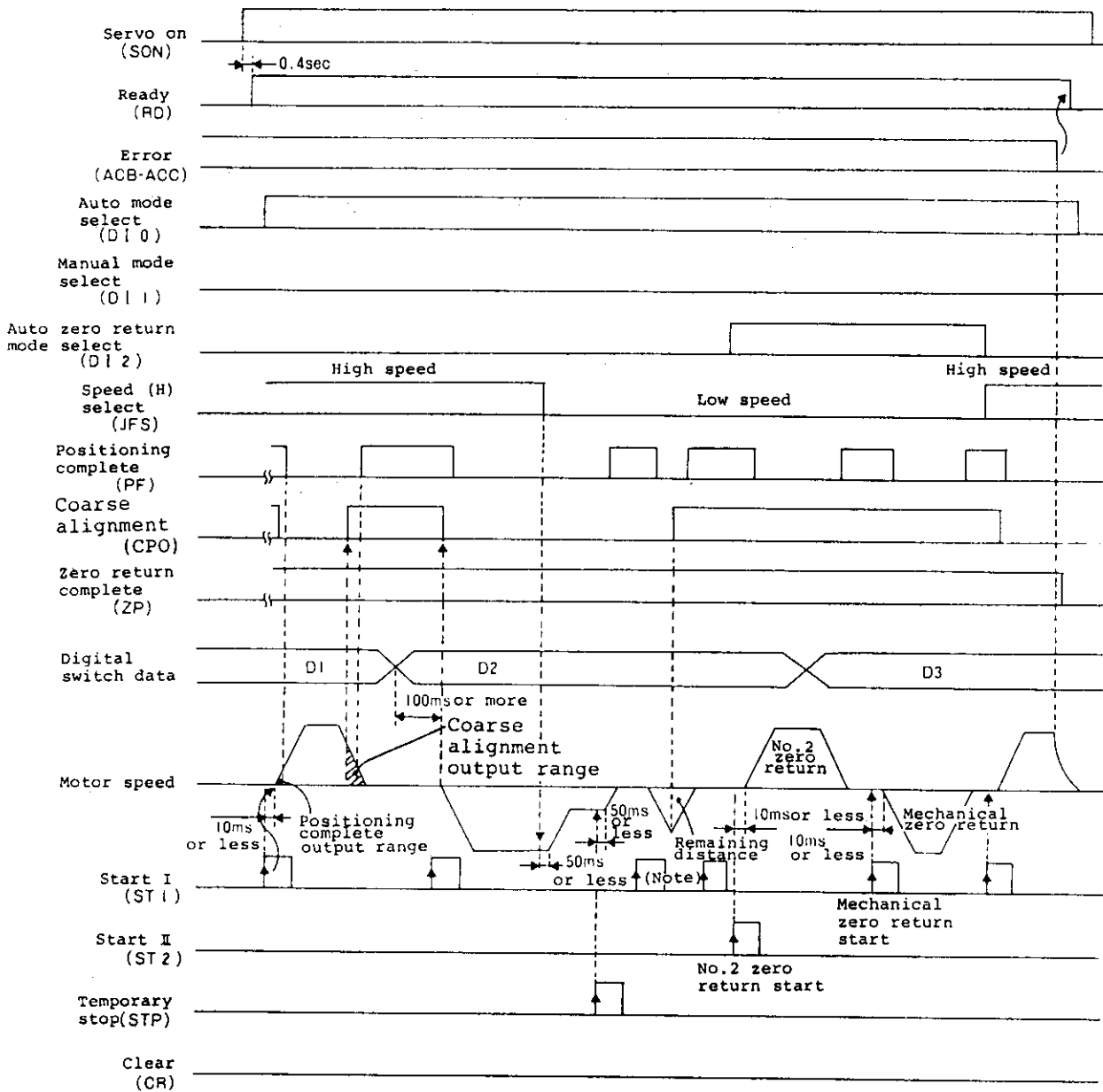

Fig. 6-6 Time chart of absolute positioning, auto mode digital switch setting operations (Motions following the completion of manual zero return after the power on)

Note: Start signal before data change will be disregarded.

6-3-3 Step positioning operation with stored data

Manual zero return shall be conducted after the power on. Otherwise, auto mode operation is disabled. If auto zero return is tried, it will raise a parameter error and it will display

3	0	6	A	L	-	-
---	---	---	---	---	---	---

. Manual operation can be done.

(1) Parameter setting

Confirm that the feeding method (parameter No.601) is set correctly. Rightmost digit is 4 like

0	0	0	4
---	---	---	---

. For any other digit, please review with regard to Section 6-1 when the regenerative option is applied.

(2) Zero return



The same operations as 6-3-2 (2) can be conducted.

(3) Manual mode operation

The same operations as 6-3-2 (2) can be conducted.

(4) Auto mode operation

Turn on auto mode select signal (DI0). Leave both manual mode select signal (DI1) and zero return signal (DI2) at Off. Under the stored data positioning mode, the absolute method only is effective and the increment method is disabled.

Operation mode select signal		DI0	DI1	DI2
		ON	OFF	OFF
Start signal	ST1	Start		
	ST2	Step reset		
	STP	Temporary stop		

- a. Number of stored data for 1 cycle is determined by parameter No.623. (Max. 16 points)
- b. Position data shall be set in parameter Nos. 501 to 516.
- c. Parameter No.623 has the priority. If No.623 is set at 10, position parameter No. 511 to 516 are disregarded so that, when No.510 is executed, it starts from

No.501 again (See the following figure)

Note: Since 0 of position data means the mechanical zero, it will return to mechanical zero immediately after the start. When the number of data is 16 or less, it is recommended to set necessary data in parameter No.623 in order to avoid the zero return by mistake.

- d. Under the following conditions, it will start from step No.1 (parameter No.501).
- I) When the power is turned off, at emergency stop or it becomes operable after the servo off.
 - II) After the manual zero return
 - III) When ST2 signal is turned on and the step No. is returned to 1.
 - IV) When it is reset after alarm.
- e. Under the following conditions, step No. will continue to proceed.
- I) Clear of remaining distance.
 - II) When it is switched between auto and manual modes.
 - III) Automatic zero return (No.2 zero return, mechanical zero return)

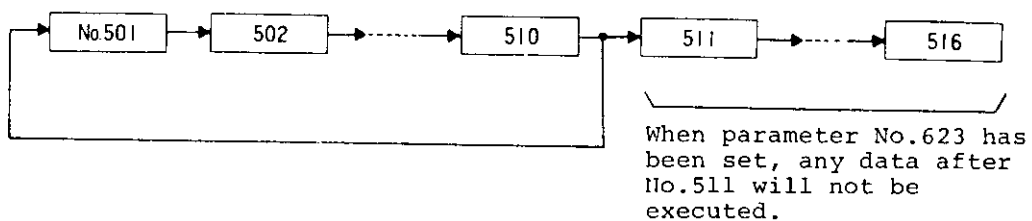

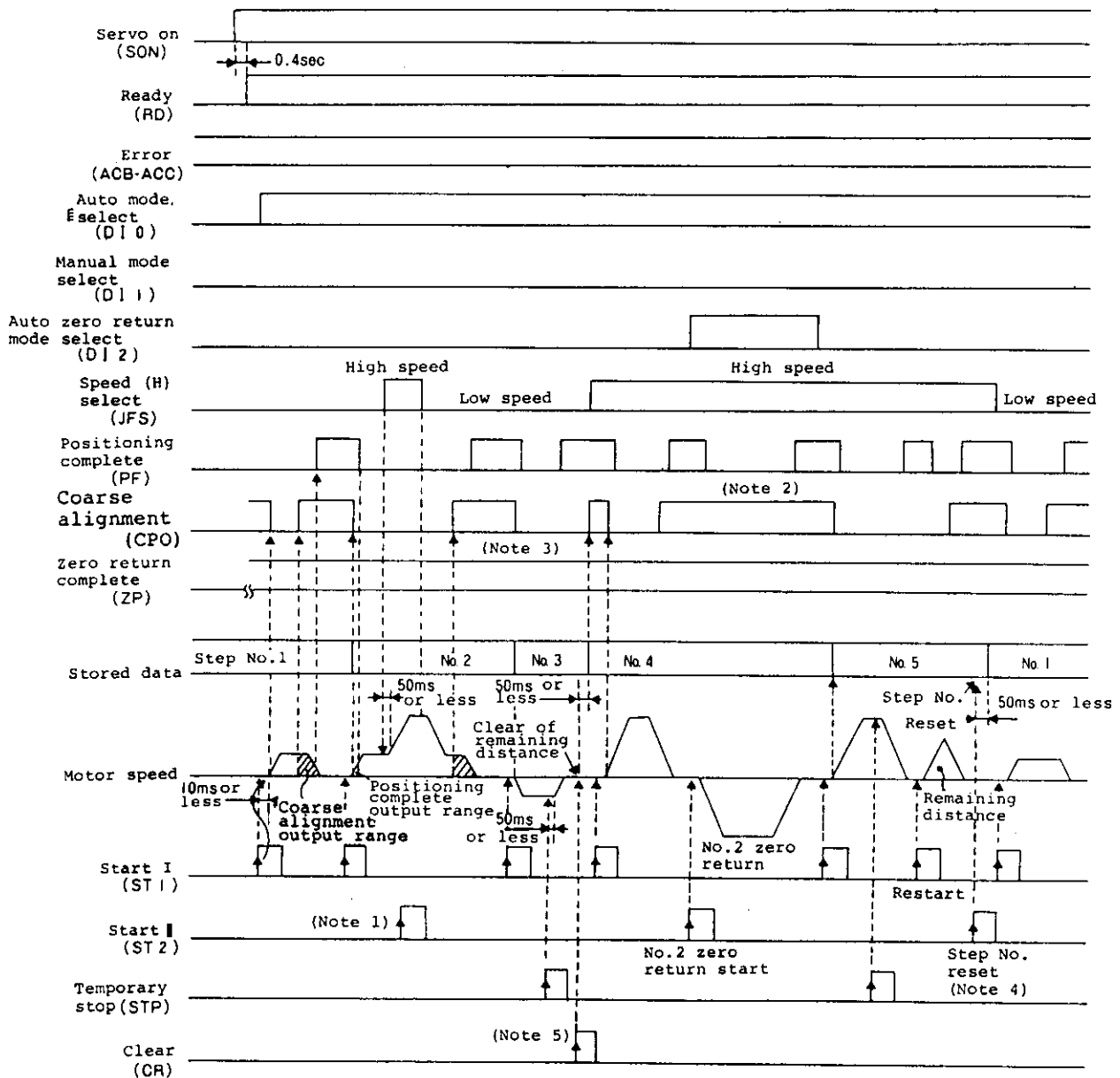

Fig. 6-7 Time chart of stored data positioning operation
(Motions following the completion of manual zero return after the power on)

- Note 1. Start signal during operation is disregarded.
- 2. During zero return, coarse alignment will be left at On.
- 3. Zero return complete signal will be left at On after manual zero return.
- 4. When the number of steps for stored data positioning (parameter No.623) is set, it will be reset automatically at the next start.
- 5. If the remaining distance is cleared, it will move a distance added up with the previous remaining distance at the next start.

6-4 Servo gain setting

Although initial settings of servo gain are as per Table 10-5, when there is any trouble such as vibrations or noises or when it is necessary to obtain the optimum performance for any specific load, it is better to set the servo gain separately with parameters.

Table 6-1 Table of servo gain

Parameter No.	Abbreviation	Content
606	PGN	Position loop gain
607	VGN	Speed loop gain
608	VIC	Speed integral compensation

(1) Method to observe the speed feedback

Synchroscope is used to check signals. Set the synchroscope afloat from the ground and make sure the probe will not contact anything other than check pins on printed circuit board.

Regarding speed feedback signal, check the speed monitor (between MO-LG of connector CPI for checking) with synchroscope. Before checking this, it is necessary to confirm that the 3rd digit from right on parameter No.710 is set at 0 for speed monitor.

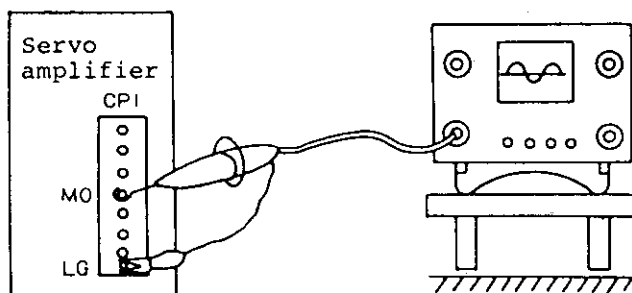

(2) Parameter setting

① Position loop gain (PGN)

Position loop gain varies depending on status of motor during stop and number of accumulated pulses on position deviation counter during operation.

A lower gain produces a larger number of accumulated pulses and time to stabilize at stop will be extended.

A higher gain may produce a larger overshoot at stop or vibrations while it is stopped. It can be determined generally based on the following table.

$$\epsilon = \frac{f}{Kp} \dots\dots\dots (6-1)$$

where, ϵ : Number of accumulated pulses (pulse)

f : Frequency of command pulse (pps)

Kp : Position loop gain (rad/s)

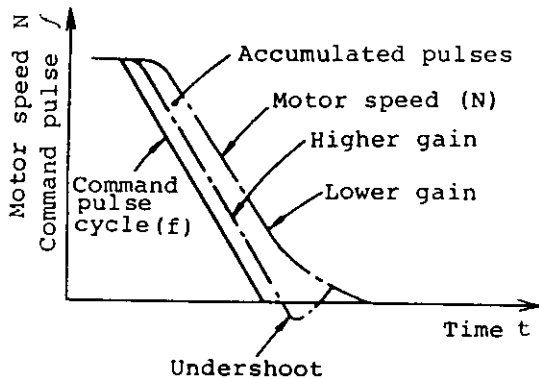

Load inertia ratio GD_L^2/GD_M^2		0	1	3	5
Set value	Standard	35	35	25	15
	Max.	100	80	40	25

[Note] If positioning gain is lowered excessively, accumulated pulses increase and result in an alarm (excessive discrepancy) at high speed operation. For example, if it is set $Kp = 6$ at operation of 400 kpps,

$$\epsilon = \frac{400 \times 10^3}{6} = 67 \times 10^3 \text{ (pulse)}$$

Since excessive discrepancy alarm is set off at 65 k pulses, this example will cause the excessive discrepancy error (alarm 52). It is necessary to determine Kp which allows $\epsilon < 65 \times 10^3$.

② Speed loop gain (VGN)

A larger load inertia ratio (GD_L^2/GD_M^2) tends to lower the speed loop gain and to delay the response. In such a case, it is necessary to set a higher VGN value.

Guideline of load inertia and VGN value is shown below.

		Load inertia ratio GD_L^2/GD_M^2	0	1	3	5
Set value	Standard	0.2, 0.3kW	70	70	150	200
		0.5 to 7.0kW	100	100	200	300
	Low inertia flat	0.3 to 3.0kW	30	30	60	100
		5.0, 7.0kW	50	50	100	150

If you increase the response to much, it will produce a higher overshoot and vibrations (noises from motor) during stop.

③ Speed integral compensation (VIC)

This is used to improve transient characteristics by increasing frequency response of speed control system. Optimum VIC will allow to set VGN at a higher level which assures a higher response.

The following table shows the guideline of load inertia ratio and VIC values.

Load inertia ratio GD_L^2/GD_M^2	0	1	3	5
Set value	20	20	30	40

(3) Method to set servo gain

Under the normal load conditions (when load inertia ratio is somewhere around 0 to 2), there is no need to change the setting from what is preset at shipment from factory.

When the load inertia is too large for stable operation, it is necessary to set the servo gain as described below.

- ① Set PGN at a little lower level. Increase the value of VGN. There will be a point where the response is too quick and the motor vibrates. Select a point sufficiently free from vibrations and set there.
- ② It is better to set VIC at the optimum value so as to obtain a possible higher setting of VGN.
- ③ After the optimum loop gain is obtained with the above ① and ②, try to find and set a value with PGN to assure the best stabilizing characteristics without overshoot at stop.

[Note] When the speed feedback signal (speed monitor) is observed with synchroscope, the wave will be interrupted signals as shown below. (In case of short acceleration time)

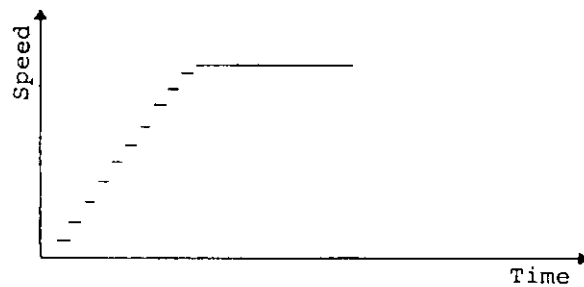

7. TROUBLESHOOTING

7-1 Investigation procedure and countermeasure for alarm occurrence

Alarms (servo protect function) are activated by the following causes. When any alarm occurred, check the alarm code on the indicator to interpret the cause and to take adequate actions for remedy.

- [Note] 1. Even if regenerative error protect (alarm code AL30), overload protect 1 or 2 (alarm code AL50, 51) has been activated, motions just before the alarm is retained in the servo amplifier. The memory can be cleared when external power supply is turned off but not with Set key.
2. If the reset is repeated with external power off against alarm codes AL30, 50, 51, component elements may be destroyed due to overheat. Be sure to resume operation only after the cause of trouble is removed completely.

Table 7-1 Check method and remedy of alarms

Alarm code	Error/Alarm	Cause	Check	Remedy
LED (CPU) On	CPU error	1. Error on servo amplifier CPU	1. Turn off/on the power. 2. Replace servo amplifier.	If reset is ineffective, replace the unit.
		2. Error on key setter CPU	Replace key setter.	If pulls and pushes of connector failed to work, replace the key setter.
AL10	Voltage drop (UV) (Power supply voltage (U, V, W) went down beyond normal level (160V).)	1. Power supply voltage dropped at start, etc. due to insufficient capacity of power supply.	Check input voltage (R, S, T) with volt meter.	Review if the capacity is adequate or not.
		2. Momentary power failure of 2.15 msec or over.	Was there no momentary power failure? Check input voltage with synchroscope.	Connect properly.
AL16	Polarity detect error (RD) (Polarity detect was not done normally on the motor at power on. Error of U, V, W phases detect.)	1. Detector's connector is displaced.	Visual check (Displaced or loose connector)	Connect properly.
		2. Trouble on detector cable (broken, short-circuited)	1. Inspect the cable. (Replace the cable) 2. Check the feedback signal of detector. Turn the motor by hand and observe with synchroscope U, V, W of check pin J4 of RF09 printed circuit board. Is not it all 'H' or 'L'? (How is it when the cable was shook.)	Repair or replace the cable. Be sure not to give strain on the cable.
		3. Error on motor's detector	Check the feedback signal of detector (Same as above).	Replace motor.

Alarm code	Error/Alarm	Cause	Check	Remedy
AL17	Card error (A/D)	Defective RP09 on printed board	Replace RP09.	Replace RP09.
AL20	No signal on detector (NS1) (Pair of differential signals of motor detector are both 'H' or 'L').	1. Detector's connector is displaced.	Visual check (displaced or loose connector)	Connect properly.
		2. Trouble on detector cable (broken, short-circuited)	Inspect the cable. (Replace cable)	Repair or replace the cable. (Be sure not to strain the cable.)
		3. Defective motor detector	Replace motor.	Replace motor.
AL30	Regenerative error (OR)	1. Parameter set error	Check parameter set value, parameter No.601 (OP1), 00□□: No regenerative option MR-RB30 01□□: Regenerative option MR-RB30 02□□: Regenerative option MR-RB50, MR-RB51	Set properly.
		2. Excessive frequency of positioning (regeneration)	1. Check regenerative brake torque, frequency of regeneration. (Is it permissible frequency?) 2. Check the value of state display Ld.	1. Reduce frequency of positioning. 2. Install regenerative option. 3. Increase motor capacity. 4. Reduce size of load.
		3. Broken regenerative power transistor. (Shortcircuit)	Check resistance of regenerative power transistor with tester.	Replace unit.
AL31	Over-speed (OS) (Motor revolutions exceeded 115% of rated revolutions.)	1. Overshoot due to smaller time constant of acceleration, deceleration.	1. Increase time constant of acceleration, deceleration. 2. Slow down the speed.	Review time constant of acceleration, deceleration.
		2. Overshoot due to unstable servo system.	1. Adjust servo gain. •Increase (decrease) VGN. •Increase VIC. •Decrease PGN. 2. Check load inertia. 3. Increase time constant of acceleration, deceleration. 4. Slow down the speed.	1. Adjust servo gain at proper value. 2. When unable to set with servo gain, ① Reduce load inertia ratio, ② Review time constant of acceleration, deceleration.
		3. Error on detector signal.	1. Replace cable. 2. Replace motor.	Replace cable. Replace motor.
		4. Parameter mis-setting.	Check if maintenance parameter NO.801 is set with motor's rated revolutions as follows. □□□2: 2000 rpm series □□□3: 3000 rpm series	Use correct unit.

Continued on the next page.

Alarm code	Error/Alarm	Cause	Check	Remedy
AL32	Overcurrent (OC) (Overcurrent beyond allowance passed through motor cable of servo amplifier.)	1. U, V, W phase of servo amplifier output were shortcircuited each other.	Check with tester for shortcircuit of wires of U, V, W.	Improve wiring.
		2. U, V, W phases of servo amplifier output were grounded.	1. Check with tester between U, V, W phases of terminal board and housing. 2. Check with tester and megohm between U, V, W phases of motor and core.	Improve grounding. Replace unit or motor.
		3. Broken servo amplifier transistor.	Check with tester the resistance between terminals of transistor module.	Replace transistor module or unit.
		4. External noises.	1. Check peripheral equipment. (Was not activated 100V class relay or valve?) 2. Is not dirt or dust stuck on printed circuit board?	Review noise protection. (See Section 4-7) Remove dirt from board.
AL33	Overvoltage (Volt on converter's mother cable exceeded 400V.)	1. Misconnection on terminal board (TE2).	Connection with regenerative option. Connection without regenerative option.	Correct the connection.
		2. Smaller time constant of acceleration, deceleration.	1. Increase time constant of acceleration, deceleration. 2. Slow down the speed.	1. Review time constant of acceleration, deceleration. 2. Review feeding speed.
		3. Regenerative resistor in servo amplifier is blown.	Check with test between C-P of terminal board (TE2). (Check about 3 minutes after charge lamp was turned off.) About 13 Ω with P \oplus , C \ominus .	Replace unit.
		4. Broken regenerative power transistor.	See alarm code AL3-3.	Replace unit.
AL37	Parameter error (PE)	Parameter data was broken.	1. Inspect if dirt is stuck on card. 2. Try to set again parameter.	1. Remove dirt from card and set again. 2. Replace card and set again.

Continued on the next page.

Alarm code	Error/Alarm	Cause	Check	Remedy
AL45	Overheated sink (OHF) (Thermal protector of cooling fin in servo amplifier was tripped.)	1. Operation exceeding continued output current of servo amplifier.	1. Check effective torque (value of state display JA). 2. Check motor input current (See Section 7-2). 3. Check motor heat-up. 4. Try to lessen load.	1. Lessen load. 2. Increase capacity.
		2. Higher frequency of positioning (regenerative).	1. Reduce frequency of acceleration, deceleration. 2. Slow down the speed.	Review frequency of positioning (regenerative).
		3. Poor cooling.	1. Check if cooling fan of servo amplifier is operating. 2. Inspect ventilation is not interrupted. 3. Check temperature of enclosed board. (0°C to +55°C)	Improve cooling method.
		4. Hunting due to unstable servo system.	See alarm code AL31-3.	
		5. Electromagnetic brake was tripped during operation	Check action of electromagnetic brake.	Improve sequence.
		6. Defective thermal protector.	Check if it does not operate even without load.	Replace unit.
AL46	Overheated motor (OHM) (Thermal protector of motor or regenerative option tripped.)	1. Overload on motor.	See alarm code 45-1.	
AL46		2. Connection error of terminal board (TE1).	G1, G2 of terminal board (TE1) and motor's thermal protector terminals are connected.	Correct connection.
		3. Poor cooling of motor or regenerative option.	Check ambient temperature around motor, regenerative option. (0 to +40°C) Is not motor exposed to heat from furnace, etc.?	Operate within 0 to +40°C.
		4. Hunting due to unstable servo system.	See alarm code AL45-4.	
		5. Defective thermal protector of motor or regenerative option.	Check with tester conductivity between thermal protector terminals of motor, regenerative option.	Replace motor. Replace regenerative option.

Continued on the next page.

Alarm code	Error/Alarm	Cause	Check	Remedy
AL50	Overload 1 (OL1) { Overload current of about 200% passed continuously. }	1. Operation beyond continued output current of servo amplifier.	See alarm code AL45-1.	
		2. Collision with machine.	1. Check if there was collision. 2. Check for normal operation of stroke end LS.	1. Review operation pattern. 2. Replace LS.
		3. Hunting due to unstable servo system.		
		4. Misconnection of motor wires. U, V, W of terminals of motor and servo amplifier are not matched.	Check connection of U, V, W.	Correct the connection.
		5. Error on detector signal.	1. Replace cable. 2. Replace motor.	1. Replace cable. 2. Replace motor.
AL51	Overload 2 (OL 2) { Max. current passed for several minutes. }	1. Collided with machine.	See alarm code AL50-2.	
		2. Hunting due to unstable servo system.	See alarm code AL45-4.	
		3. Misconnection of motor wires. U, V, W of terminals of servo amplifier and motor are not matched.	See alarm code AL50-4.	
		4. Error on detector signal.	See alarm code AL50-5.	
		5. Voltage drop on mother cable in unit.	Charge lamp is lighted.	Replace unit.
AL52	Excessive error (EEX) { Deviation counter recorded more than 65 K of accumulated pulses. }	1. Smaller time constant of acceleration, deceleration.	Increase time constant of acceleration, deceleration. Smaller time constant of acceleration, deceleration interrupts the motor to follow the command and results in overflow of accumulated pulses.	Extend time constant of acceleration, deceleration.
		2. It collided with machine.	Check if there was collision with machine.	Review the pattern of operation.
		3. Smaller setting of servo gain PGN.	Increase the set value of PGN.	Set at a proper value.
		4. Error on detector signal.	See alarm code AL50-5.	
		5. Voltage drop on mother cable of unit.	See alarm code AL51-5.	

Continued on the next page.

Alarm code	Error/Alarm	Cause	Check	Remedy
AL55	Emergency stop (EMG) (Connection between B-R terminals of terminal board has been opened due to emergency stop, etc.)	1. Emergency stop circuit was activated.	Is not it open between B-R of terminal board.	Reset emergency circuit.
		2. Defective contactor point (MC) in unit.	1. Check the conductivity between contactor points. 2. Was there any excessive shock on servo amplifier?	Replace unit.
AL60	Failed zero return. (ZER) (Zero return, failed.)	1. Passed over proximity dog before slow down/stop at detection of proximity dog.	1. Is it insufficient the length of proximity dog? 2. Higher zero return velocity disables stop. 3. Longer slow down time exceeds proximity dog.	Review the length of proximity dog and the pattern of zero return.
		2. No pass over Z phase.	Proximity dog is too close and Z phase cannot be detected before the dog is tripped again.	Adjust length of proximity dog.
AL-- (Note)	Zero return incomplete (ZER) (Autostart was tried before zero return with dog.)	1. Autostart was tried before zero return with dog was done during positioning method operation.		Zero return with dog was done.
		2. Zero return with dog was done on a dog.	Is proximity dog detect terminal (DEC) short-circuited with SG?	Conduct zero return after dog was released manually.

(Note): Base cut-off is ineffective. When alarm occurred, conduct zero return with dog. Press **SET** key to clear alarm display.

Table 7-2 Alarm of key setter

Alarm code	Error/Alarm	Cause	Check	Remedy
WD turn on	CPU error	1. Error on key setter CPU.	Replace key setter.	Pull and push connector. If it does not work, replace key setter.
		2. Error on servo amplifier CPU.	CPU error lamp of servo amplifier is turned on. 1. Switch off/on the power. 2. Replace servo amplifier.	If reset does not work, replace unit.

7-2 Troubleshooting

When there was any error, check and clear the cause with following steps. When any of following procedures is not applicable, amplifier or motor has broken down or parts have been damaged, please contact your dealer or our service department.

① Motor does not turn.

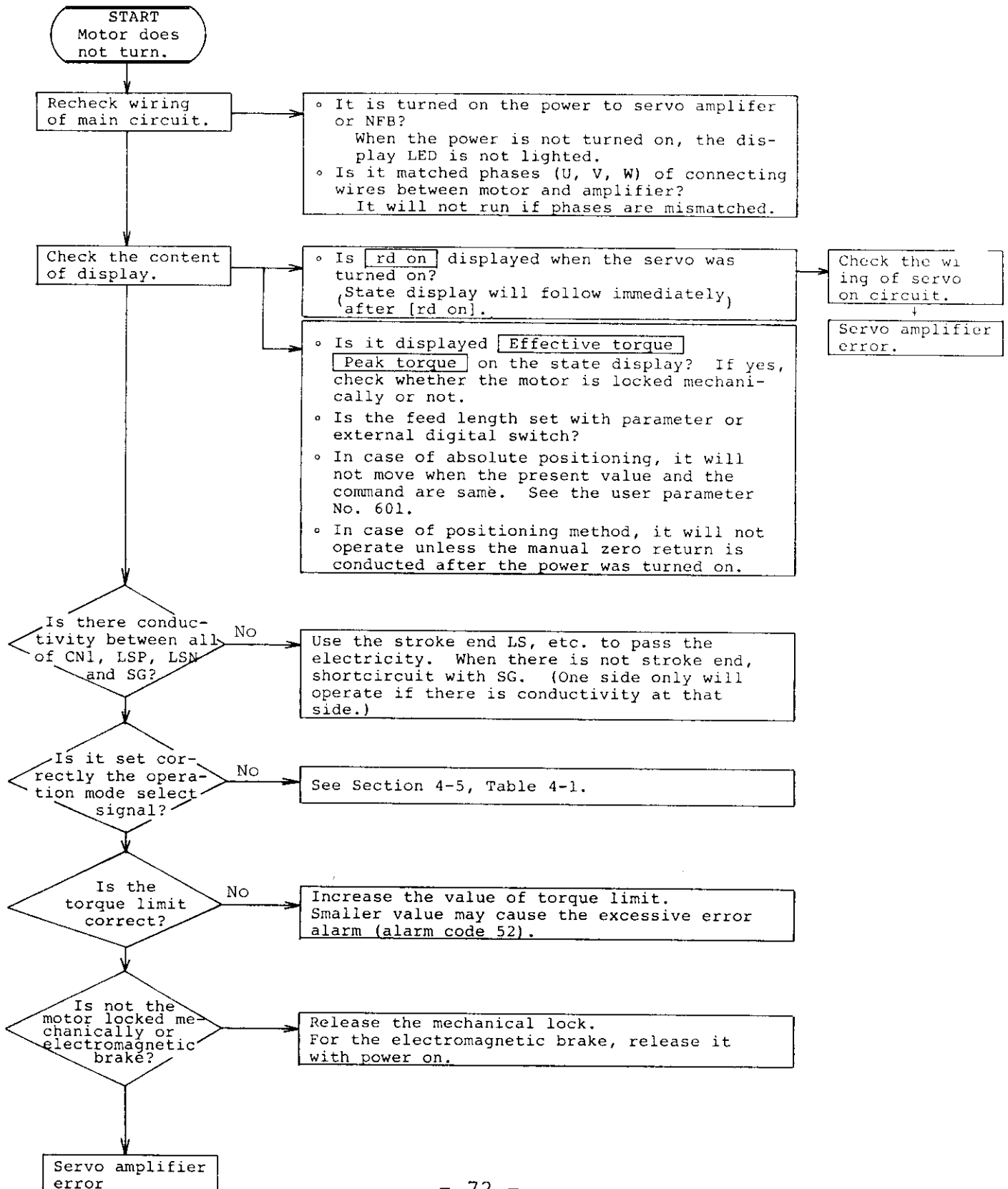

② Unstable revolutions

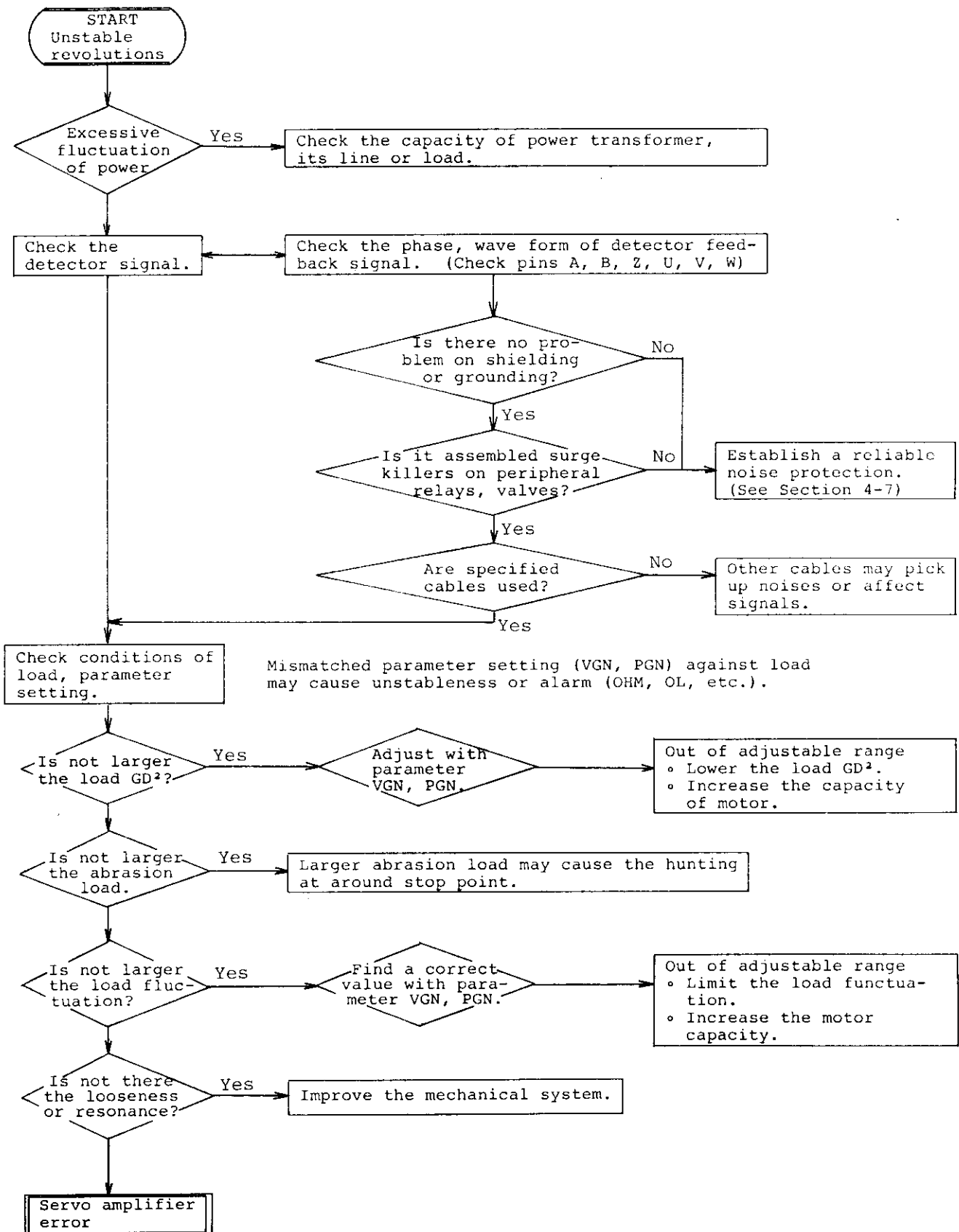

③ Poor positioning accuracy

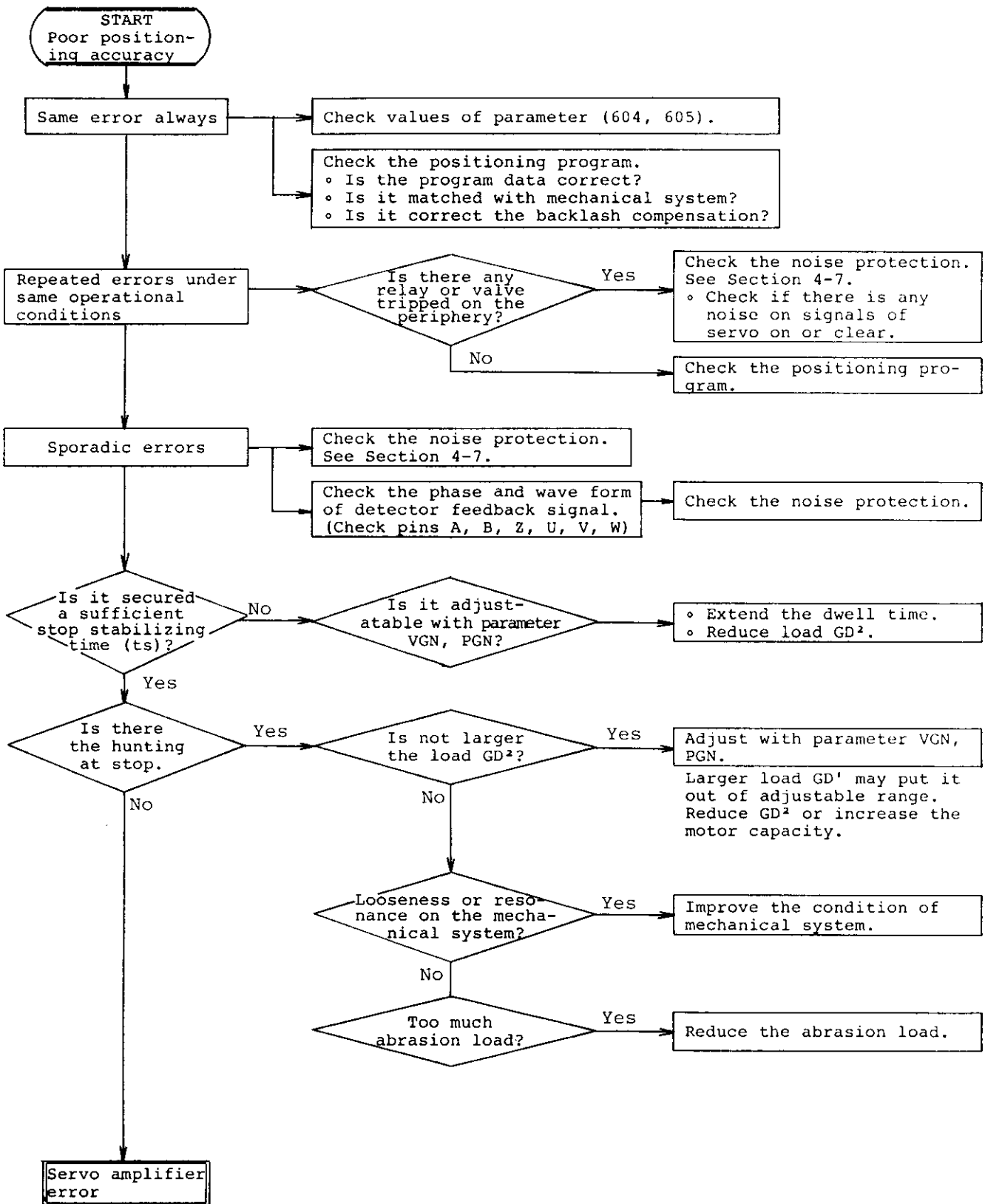

④ Erratic zero positioning

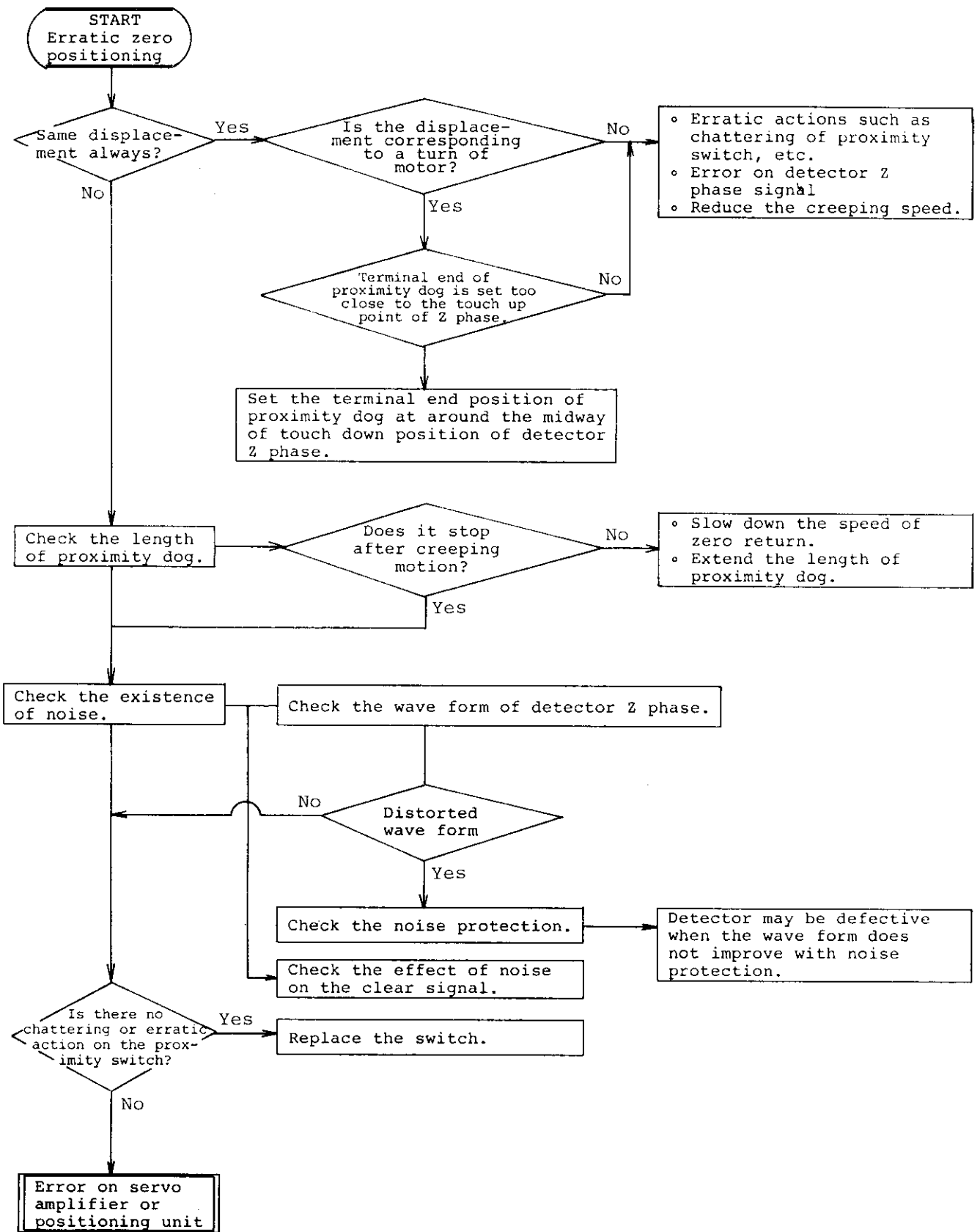

8. MAINTENANCE AND INSPECTION

8.1 Cautions and inspection

If any trouble occurs with your servo system, perform inspection in accordance with the following instruction:

CAUTIONS

MELSERVO-SA servo amplifier uses large capacitor.

After the power is turned off, the capacitor remains charged for a while.

Before making inspection, check that the CHARGE lamp (red lamp under P.C. board) is off.

Parts at upper portion of P.C. board RF08 are at high voltage. During inspection, use care not touch these parts.

Do not use a megger to check insulation resistance, withstand voltage, etc. Otherwise the servo amplifier might be damaged seriously.

General inspection

- (1) Is alarm code displayed?
- (2) Is the same trouble reproducible (check alarm history)?
- (3) Are temperatures of motor and servo amplifier, and ambient temperature usual?
- (4) When the trouble occurred (during acceleration, deceleration or constant-speed operation)?
- (5) Is direction of rotation of the motor correct?
- (6) Did instantaneous power failure occur?
- (7) Does the trouble occur when specific operation is done or specific reference signal is given?
- (8) Does the same trouble occur frequently (what is the frequency)?

- (9) Did the trouble occur when load was applied to the motor?
- (10) Did the servo motor or servo amplifier remedied in the past?
- (11) How long have the servo motor and servo amplifier been used?
- (12) Is the supply voltage proper?
Does voltage regulation change remarkably during operation?

8-2 Voltage and current measurement

(1) Motor voltage measurement

Voltage output from the servo amplifier is under PWM control and therefore has pulse waveform. To measure this type of voltage accurately, use a filter circuit shown to the right and a rectifier type voltmeter.

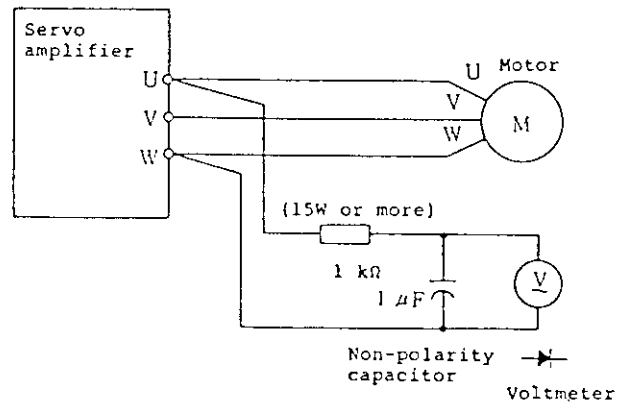

(2) Motor current measurement

Since pulse waveform of current is transformed to sine waveform by reactance of the motor, a moving core type current meter can be used.

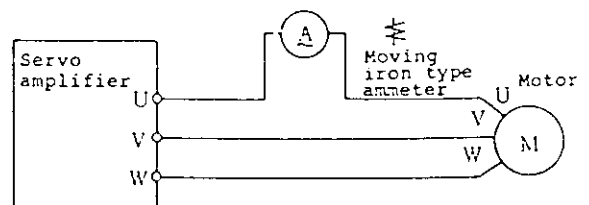

- (3) To measure power, use an electrodynamicometer type instrument.

(4) Other instruments

When a synchroscope or digital voltmeter is used, do not ground it. Use an instrument requiring input current less than 1mA.

8-3 Periodic inspection

The servo amplifier is a static equipment, and requires no daily maintenance and inspection.

However, perform inspection at least yearly.

The servo motor is of brush-less type, and requires no periodic maintenance.

It is recommended to check for sound level and vibration from time to time.

(1) Cautions

When inspection is made under live condition, pay attention to the cautions described in para. 8.1 and 8.2.

(2) Inspection points

- a. Check if dust deposit is found in the servo amplifier and clean, if necessary.
- b. Check terminal screws for looseness and retighten.
- c. Check if any component is defective or damaged (discoloration due to overheat, open circuit, etc.).
- d. For continuity test of control circuit, use a multi-meter (high-resistance range). Do not use a megger or buzzer.
- e. Check cooling fan for operation.
- f. Check that motor bearings, brake, etc. do not generate abnormal sound.
- h. Check cables (particularly, detector cable) for condition.

8-4 Storage

(1) Motor

When the motor is kept stored for any length of time, pay attention to the following:

- a. Store it in clean and dry location.

Storage temperature	Storage humidity
-15°C to +70°C	90% RH or less

Note: To be free from freezing and condensation.

- b. If the motor is stored outdoor or in humid environment, cover it properly to prevent entrance of rain water and dust.
- c. When once used motor is stored long, apply anti-corrosive compound to shaft and other unprotected surfaces.

(2) Servo amplifier

It is not recommended to store the servo amplifier long. If long storage is inevitable, store it with the following caution.

- a. Store it in clean and dry location.

Storage temperature	Storage humidity
-20°C to +65°C	90% RH or less

Notes:

1. To be free from freezing and condensation.
 2. Storage temperature shown above is for short-term storage.
- b. Because it is of open construction, use care not to allow entrance of dust and foreign matter.

8-5 Layout on the printed circuit board

Short pins, check pins and switches are laid out as shown in Fig. 8-1. Though the ordinary inspection and state check are carried out by the key setter and indicator, check the following states and signals as necessary. The short pins and switches which are designated "maker setting purpose" shall not be operated by the user.

① LEDs

Table 8-1 LED list

Charge lamp (red)	Located under the unit and on the lower side of the printed circuit board. It is lit while the system is energized.
CPU error indication lamp (red)	Located on the printed circuit board RF81. It is lit when the CPU error occurs in the servo amplifier.

② Switches

The following switches are provided. Set the switches according to the operation purpose.

Table 8-2 Setting switch list

Printed board	Switch name	Set at delivery	
RF82	MODE	Push-button switch	Used for display of state and alarm and setting of parameter. (Refer to the Chapter 5)
	UP		
	DOWN		
	SET		
	SW-5 1	OFF	It is turned on to set the special parameter and check the maintenance parameter.
	SW-5 2 to 4	OFF	Maker setting purpose
RF08 (RF18)	CS1	0	Maker setting purpose

③ Short pins

The short pins shown in Fig. 8-1 are provided. Check the mounted state.

④ Check pins

The functions and voltage waveforms of the check pins on the printed circuit board are shown below. The check pin terminals J2 thru J7 are located on the printed circuit board RF08 or RF18, and CP1 is located on RF82. For pin locations, refer to Fig. 8-1.

Table 8-3 Check pin list

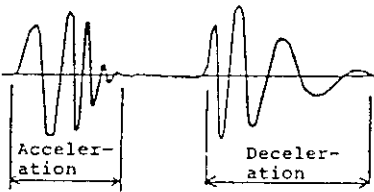
Terminal name	Signal name	Ground terminal	Signal, content and waveform																																																																																	
J2	IU IV AG	J2(AG)	<p>Motor U-phase current Motor V-phase current Control ground</p> <div style="border: 1px solid black; padding: 2px; display: inline-block;">Waveform example</div> IU/IV <p>The waveform is different depending on the load, etc.</p>  <table border="1" style="margin-top: 10px;"> <thead> <tr> <th>Motor</th> <th>Converted value</th> </tr> </thead> <tbody> <tr> <td>HA-SA22, 32, 33</td> <td>3.0 (A/V)</td> </tr> <tr> <td>HA-52, 53</td> <td>6.2</td> </tr> <tr> <td>102, 103, 152</td> <td>10.4</td> </tr> <tr> <td>202, 153</td> <td>15.6</td> </tr> <tr> <td>302</td> <td>20.8</td> </tr> <tr> <td>351</td> <td>20.8</td> </tr> <tr> <td>502</td> <td>31.2</td> </tr> <tr> <td>702</td> <td>41.6</td> </tr> </tbody> </table> <table border="1" style="margin-top: 10px; float: right;"> <thead> <tr> <th rowspan="2">Motor</th> <th colspan="3">Rated current (A)</th> </tr> <tr> <th>Standard 2000 and 3000 rpm</th> <th>Low inertia</th> <th>Pancake</th> </tr> </thead> <tbody> <tr> <td>HA-SA 22</td> <td>2</td> <td>-</td> <td>-</td> </tr> <tr> <td>32</td> <td>-</td> <td>-</td> <td>2.8</td> </tr> <tr> <td>33</td> <td>2</td> <td>-</td> <td>-</td> </tr> <tr> <td>52</td> <td>3</td> <td>3.5</td> <td>3.5</td> </tr> <tr> <td>53</td> <td>3</td> <td>-</td> <td>-</td> </tr> <tr> <td>102</td> <td>5.5</td> <td>7</td> <td>7</td> </tr> <tr> <td>103</td> <td>5</td> <td>-</td> <td>-</td> </tr> <tr> <td>152</td> <td>8</td> <td>9.4</td> <td>-</td> </tr> <tr> <td>153</td> <td>8</td> <td>-</td> <td>-</td> </tr> <tr> <td>202</td> <td>10</td> <td>14</td> <td>14</td> </tr> <tr> <td>302</td> <td>-</td> <td>18</td> <td>18</td> </tr> <tr> <td>352</td> <td>16</td> <td>-</td> <td>-</td> </tr> <tr> <td>502</td> <td>24</td> <td>28</td> <td>28</td> </tr> <tr> <td>702</td> <td>37</td> <td>37</td> <td>-</td> </tr> </tbody> </table>	Motor	Converted value	HA-SA22, 32, 33	3.0 (A/V)	HA-52, 53	6.2	102, 103, 152	10.4	202, 153	15.6	302	20.8	351	20.8	502	31.2	702	41.6	Motor	Rated current (A)			Standard 2000 and 3000 rpm	Low inertia	Pancake	HA-SA 22	2	-	-	32	-	-	2.8	33	2	-	-	52	3	3.5	3.5	53	3	-	-	102	5.5	7	7	103	5	-	-	152	8	9.4	-	153	8	-	-	202	10	14	14	302	-	18	18	352	16	-	-	502	24	28	28	702	37	37	-
Motor	Converted value																																																																																			
HA-SA22, 32, 33	3.0 (A/V)																																																																																			
HA-52, 53	6.2																																																																																			
102, 103, 152	10.4																																																																																			
202, 153	15.6																																																																																			
302	20.8																																																																																			
351	20.8																																																																																			
502	31.2																																																																																			
702	41.6																																																																																			
Motor	Rated current (A)																																																																																			
	Standard 2000 and 3000 rpm	Low inertia	Pancake																																																																																	
HA-SA 22	2	-	-																																																																																	
32	-	-	2.8																																																																																	
33	2	-	-																																																																																	
52	3	3.5	3.5																																																																																	
53	3	-	-																																																																																	
102	5.5	7	7																																																																																	
103	5	-	-																																																																																	
152	8	9.4	-																																																																																	
153	8	-	-																																																																																	
202	10	14	14																																																																																	
302	-	18	18																																																																																	
352	16	-	-																																																																																	
502	24	28	28																																																																																	
702	37	37	-																																																																																	

Continued on the next page.

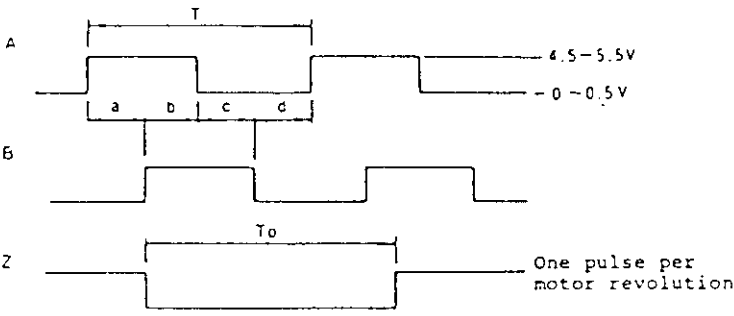
Terminal name	Signal name	Ground terminal	Signal, content and waveform
J4	A B Z	Below the right of the stud	<p>Encoder Phase A Encoder Phase B Encoder Phase Z</p> <p>Waveform example CCW revolution viewed from the load shaft of the motor.</p>  <p> $T = \frac{60}{N \times 3000} \text{ (sec)}$ N: Motor revolution (rpm) Encoder: 3000 pulse/rev $a, b, c, d = \frac{1}{4}T \pm \frac{1}{8}T$ $T_0 = T - 3T$ </p>

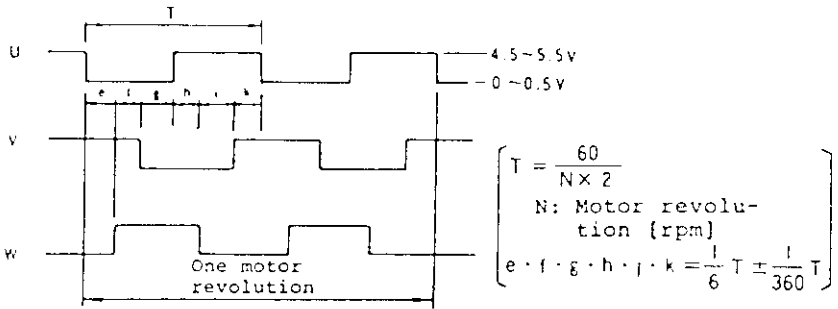
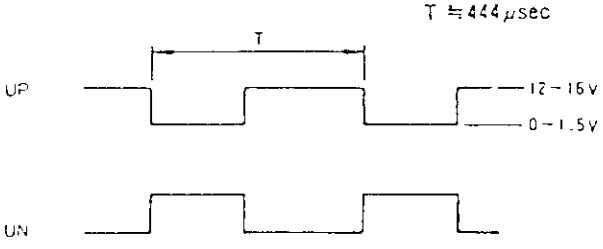
Terminal name	Signal name	Ground terminal	Signal, description and waveform
J4	U V W	Lower right of stud	<p>U phase of the encoder V phase of the encoder W phase of the encoder</p> <p>Waveform example</p> <p>In case of CCW revolution viewed from the load shaft side of the motor,</p> 
J5	UP UN VP VN WP WN	Lower right of stud	<p>P side, U phase of PWM output N side, U phase of PWM output P side, V phase of PWM output N side, V phase of PWM output P side, W phase of PWM output N side, W phase of PWM output</p> <p>Waveform example</p> <p>In case of servo lock,</p> 

Continued on the next page.

Terminal name	Signal name	Ground terminal	Signal, description and waveform
J6	5G OR	J5(5G)	<p>Analog ground Regenerative transistor off signal.</p> <p>Waveform example</p>
J7	P5 5G P15 N15 15G AN	J7(5G)	<p>+5V (4.75 to 5.25V) Control ground +15V (14.25 to 15.75V) -15V (-14.25 to -15.75V) Control ground Analog check terminal</p>
CPI	VC TLP TLN MO PP NP PA PB PZ LG SG	LG	<p>Over-ride command voltage 0 to $\pm 10V$</p> <p>Monitor output signal $\pm 8V$/rated revolution speed and maximum torque</p> <p>⊕ : Forward or reverse powering, forward regenerative torque ⊖ : Reverse or forward powering, reverse regenerative torque</p> <p>Full scale: $\pm 10V$</p> <p>Encoder Phase A } Same as the check Encoder Phase B } terminal J4 of the Encoder Phase Z } printed circuit boards RF09 and RF19</p> <p>Control ground Contact point input signal common</p>

⑤ Layout on the printed circuit board

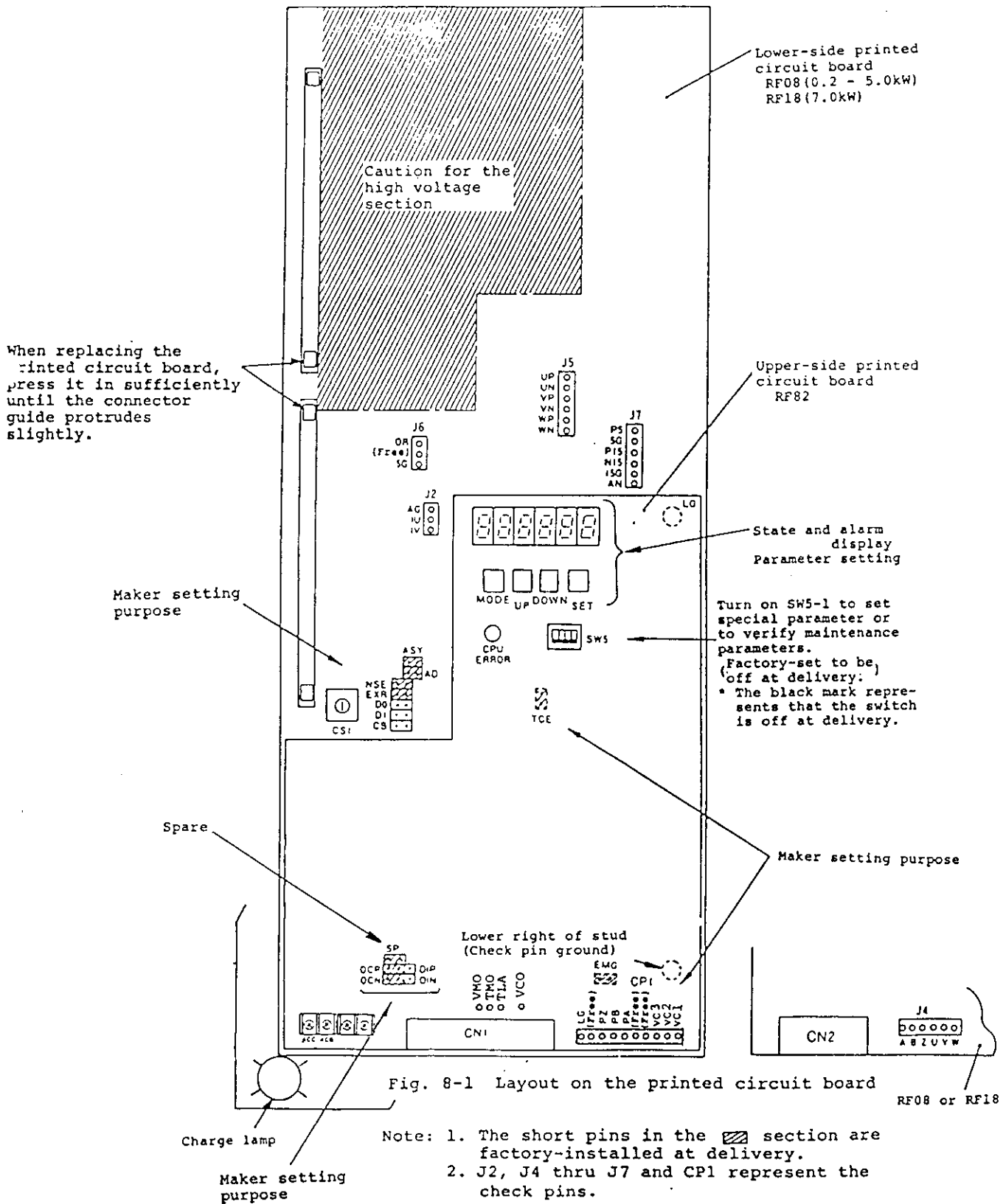

9. INPUT/OUTPUT TERMINALS

9-1 Description of terminals

Table 9-1 Table of external terminals

Signal name	Symbol	Connector pin No.	Function and application	I/O division (Note)
AC power	R,S,T	TE1	200V, 50Hz, 200/220V, 60Hz	
Emergency stop	B		Used to provide the emergency stop circuit after removing an internal wire (red wire between B-R terminals).	
Motor output	U,V,W		Connect with the motor power supply terminals U, V, W. Order of phases cannot be changed.	
Motor protection	G1, G2		Connect with motor's thermal protector terminal (red).	
Regenerative brake resistor	P,C, (D)	TE2	A short bar is connected between P-D at the shipment from factory. (0.5~5.0 kW) When the regenerative option is used, the option is connected between P-C after the short bar was removed. For 7.0 kW models, it must be equipped with the regenerative unit (MR-RB51) which is provided as the standard accessory.	
Trouble	ACB, ACC	TE3	ACB-ACC terminals will be opened when the base cut off is activated with the operation of protective circuit. (Contact point capacity AC 230V, 0.3A, DC 30V, 0.3A Closed with R load, no electricity.)	
Grounding		Housing	1 point grounding with motor. Connected with the neutral point of power filter and the housing. Must be connected by 1 point grounding with motor grounding.	
Servo on	SON	CN1 9	Servo start signal terminal. If SG terminals are shortcircuited, the contactor trips, the dynamic brake is released and it becomes ready for operation.	DI-1
Proximity dog or restart	DEC	10	Zero return proximity dog detector terminal. (b contact) When SG is opened during manual zero return, it will slow down to the creeping speed and, when it was shortcircuited again, arrives at the mechanical zero as Z signal is detected. In case of roll feeding, it is the restart signal after temporary stop.	
Feed speed (H) select	JFS	11	When it is shortcircuited between SG, it will take the speed set with parameters 609, 611.	
Temporary stop	STP	12	When it is shortcircuited between SG, it will stop temporarily during the auto operation.	

Continued on the next page.

Signal name	Symbol	Connector pin No.	Function and application	I/O division (Note)
Forward stroke end	LSP	24	Forward stroke end LS terminal. Forward motion will be prohibited if it is opened between SG but reverse motion is allowed. To move forward, shortcircuit between LSP-SG using the stroke end LS (or directly if LS is not used).	
Reverse stroke end	LSN	25	Reverse stroke end terminal. Same as above.	
Clear	CR	27	Clear terminal. With shortcircuit between SG, the position deviation counter will be cleared. If it is shortcircuited after a temporary stop, the remaining distance will be reset.	
Auto mode select	DI0	23	With shortcircuit between SG, the auto mode is selected. (See Table 4-1)	
Manual mode select	DI1	42	With shortcircuit between SG, the manual mode is selected. (See Table 4-1)	
Manual remote or zero return mode select	DI2	43	With shortcircuit between SG, under the roll feeding mode, it enables to operate with JOG with start signals ST1 and ST2. Under the positioning mode, the zero return mode is selected. (See Table 4-1)	
Start I	ST1	28	It will start with shortcircuit between SG. (See Table 4-1)	
Start II	ST2	29	It will start with shortcircuit between SG. (See Table 4-1)	
Ready	RD	<u>CN1</u> 49	Ready signal output terminal. Electricity will be conducted between SG when the servo has been turned on and it is ready for operation.	DO-1
Positioning complete	PF	48	Positioning complete signal output terminal. Electricity will be conducted between SG when it is within the range of set positioning complete.	
Coarse alignment	CPO	44	Coarse alignment signal output terminal. Electricity will be conducted between SG, when it is within the range of set coarse alignment.	
Zero return complete	ZP	45	It is output after the completion of manual zero return.	
Driver power supply	VDD	46, 47	Driving power supply for the interface. About 24 DVC will be output. Allowance current max. 200 mA (Sum of current for in/output relay driving shall be limited under 100 mA.)	
Common	SG	3, 14, 26, 30	Common terminals for contact point input signals. They are not connected with commons of control circuit.	

Continued on the next page.

Signal name	Symbol	Connector pin No.	Function and application	I/O division (Note)
Override	OVR	33	Override command input terminal. Input resistance 10~12 k ohm. 0 ~ ±10VDC is applied. It will be 100% override with 0V and 0% with -10V.	Analog input
Monitor	MO	40	Either of motor speed or torque will be output with the internal select. ±8V will be output with the max. ±10V, 1mA rated revolutions or the max torque output.	Analog output
DC power supply	P15R	1	+15V DC power supply terminal. Used as the power supply for override setting, etc. Allowance current max. 30mA.	
	N15R	2	-15V DC power terminal. Used as the power supply for override setting, etc. Allowance current max. 30mA.	
Control common	15G	34, 36, 39, 41	Common terminal for control signals. It is not connected with SG. It is connected with pulse array commons (4, 5) internally.	
Shield	SD	6, 37	Shall be connected with one side of shield wires.	
Encoder output (Line driver system)	LA	21	3,000 pulses for LA, LAR, LB, LBR for each turn of motor. 1 pulse for LZ. Phase of LA is advanced by $\pi/2$ over LB during CCW revolutions of motor. LA, LAR, LB, LBR can be set with dividing of 1/1, 1/2, 1/4 by means of the parameter setting.	DO-2
	LAR	22		
	LB	19		
	LBR	20		
	LZ	7		
Encoder output (Open collector method)	LZR	8		
	FPA	32	FPA, FPB are capable to output 3,000 pulses per motor turn by means of internal select. OP can output 1 pulse per each motor turn. During motor's CCW revolutions, FPA is advanced by $\pi/2$ against FPB, FPA, FPB can be set with dividing of 1/1, 1/2, 1/4 with the parameter setting.	DO-2
	FPB	31		
OP	50			
Pulse array common	LG	4, 5	Common terminals for control signal. It is not connected with SG.	
Detector signal		CN2	Shall be connected with the motor detector.	
RS-232 specs.		CN3	It is connected with the special purpose key setter MR-SU.	

Note: See Section 9-2 for the I/O interface.

9-2 Input/output interface

Details of the interfaces (See Table 9-1 I/O classification) of various signals listed in Section 9-1, Table 9-1 are as described hereunder. You will find the guide for connection with peripheral equipment.

(1) Digital input interface DI-1

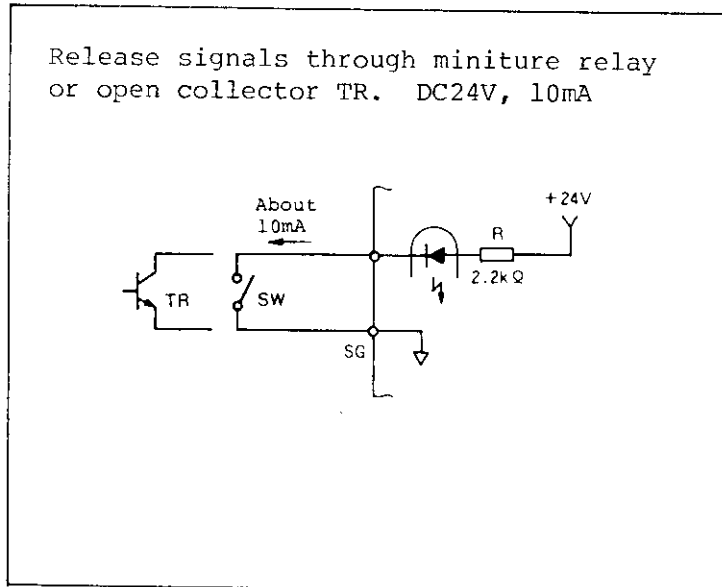

(2) Digital output interface DO-1

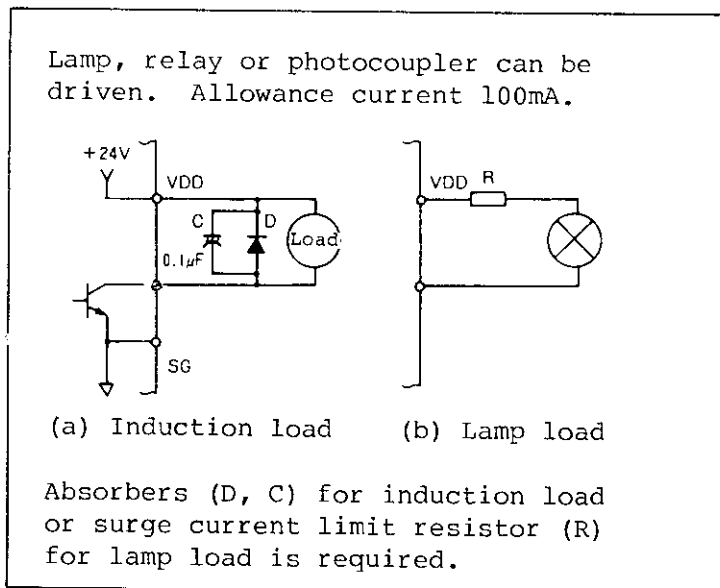

(3) Encoder pulse array output interface DO-2

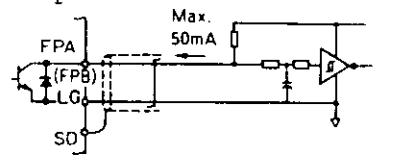
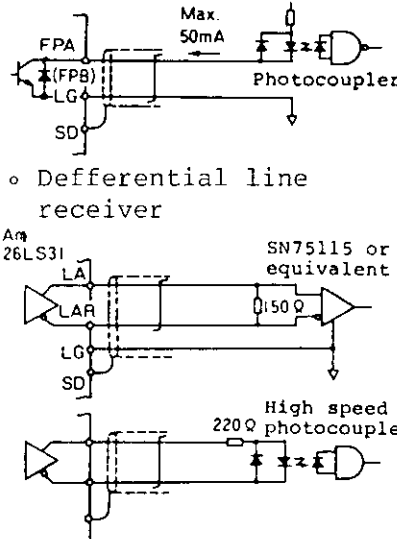
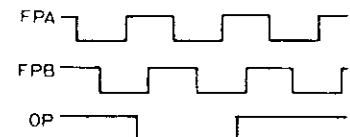
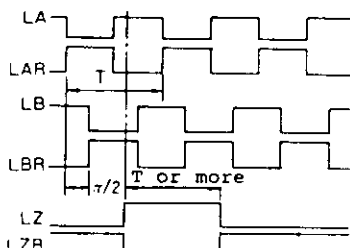
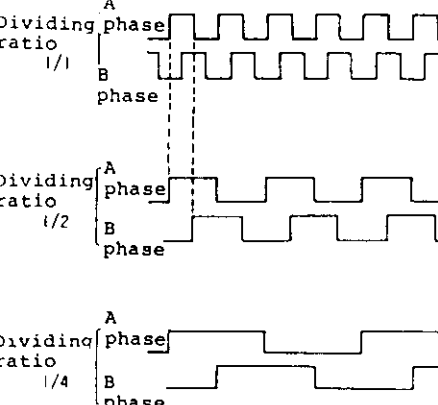
① Example of interface	② Relation of phases	③ Dividing wave form
<p>o Open collector</p>  <p>Max. 50mA</p> <p>5-24V</p> <p>Max. 50mA</p> <p>Photocoupler</p> <p>o Defferential line receiver</p>  <p>26LS31</p> <p>SN75115 or equivalent</p> <p>150Ω</p> <p>High speed photocoupler</p> <p>220Ω</p>	<p>o Open collector output signal</p> <p>With CCW revolutions of motor</p>  <p>FPA</p> <p>FPB</p> <p>OP</p> <p>o Differential output signal</p> <p>With CCW revolutions of motor</p>  <p>LA</p> <p>LAR</p> <p>LB</p> <p>LBR</p> <p>LZ</p> <p>LZR</p> <p>T</p> <p>$\pi/2$</p> <p>T or more</p> <p>Touch up of LZ signal has deviation of $\pm 3/8T$.</p>	<p>When the pulse was divided to 1/2 or 1/4 with parameter setting (ENR), following wave forms will be obtained.</p> <p>With CCW revolutions of motor</p>  <p>Dividing ratio 1/1</p> <p>A phase</p> <p>B phase</p> <p>Dividing ratio 1/2</p> <p>A phase</p> <p>B phase</p> <p>Dividing ratio 1/4</p> <p>A phase</p> <p>B phase</p>

(4) Analog input

(5) Analog output

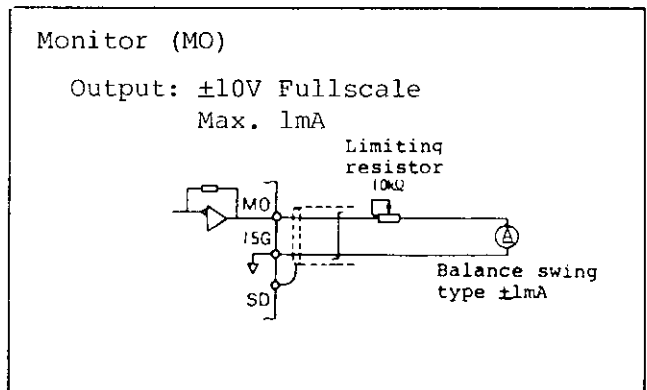
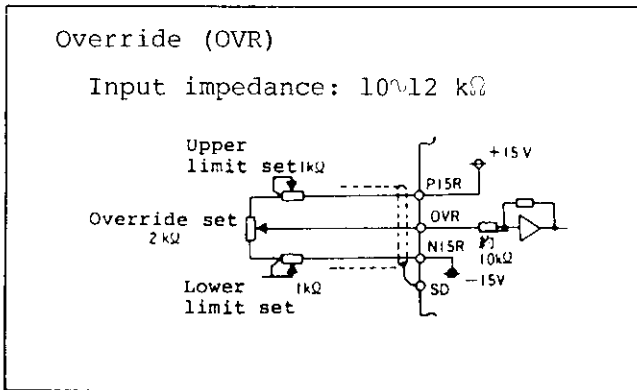

10. DISPLAY AND PARAMETER LIST

10-1 Operation status monitor

Following state displays are available during operation. Displays can be switched optionally with \uparrow \downarrow and **SHIFT** keys. Please remember that the servo monitor may be disabled with key lock in some occasions.

Table 10-1 List of state displays

Mode	Name	Symbol	Range, unit	Description (Example of display)
Command onitor	Present position	-	-999999 to 999999x10 ^(STM) μ m Unit varies depending on parameters.	<ul style="list-style-type: none"> In case of roll feeding, it displays the command position and, with the start signal on, the present position is shown starting from 0. Same applies in case of JOG feed. There is no \ominus position. In case of positioning mode, it displays the present position starting from 0 which is the mechanical zero. Normal decimal point will not be shown at \ominus side and, instead, it will be lighted at other figures. Positioning at \ominus side is available only with the positioning using the stored data. The normal decimal point indicates the position in mm which can be determined by the setting with parameter No.603. <p>\ominus side [2 . 0 0 0 0] [2 0 0 0 0] \oplus side display</p>
	Remaining distance	-	0 to 999999 x10 ^(STM) μ m	It shows the remaining distance which if the difference between the present and the command positions. [1 1 1 1 0]
	JOG feed length	-	-999999 to 999999 x10 ^(STM) μ m	<ul style="list-style-type: none"> In case of roll feeding, if JOG is started, it displays the distance of movement starting from 0. In case of positioning mode, it shows the present position. Display of \ominus side is same as that of present position. It can be cleared with 0 or END key. <p>[2 5 0 0]</p>
	Override	od	0 to 200%	It shows the value set as the override. When the override is disabled with a parameter, it displays 100. [0 1 0 0]
	Stored data step No.	no	1 to 16	During the positioning with stored data, it shows the step No. which is under execution. At the end of operation, the display changes. [n 0 1 6]

Continued on the next page.

Mode	Name	Symbol	Range, unit	Description (Example of display)
Servo moni- tor	Accumulated feedback pulse	-	-999999 to 999999 pulse	After the end of preparation (ready), the count of travel with motor is displayed. (3000 x 4 = 12000 pulses/rev.) It will start from 0 again after it passed 999999. It will be reset and display '0' if <input type="button" value="0"/> or <input type="button" value="END"/> key is hit. Decimal points will be shown at all figures of the pulse (minus number) of reverse movement (when the motor turns in CW direction). <div style="display: flex; justify-content: space-around; align-items: center;"> <div style="text-align: center;"> <input type="text" value="9"/> <input type="text" value="9"/> <input type="text" value="9"/> <input type="text" value="9"/> <input type="text" value="9"/> <input type="text" value="9"/> (Reverse) </div> <div style="text-align: center;"> <input type="text" value=""/> <input type="text" value=""/> <input type="text" value=""/> <input type="text" value=""/> <input type="text" value=""/> <input type="text" value="0"/> </div> <div style="text-align: center;"> <input type="text" value="9"/> <input type="text" value="9"/> <input type="text" value="9"/> <input type="text" value="9"/> <input type="text" value="9"/> (Forward) </div> </div>
	Motor revolutions	r	-2000 to 2000rpm or -3000 to 3000rpm	Number of motor revolutions is displayed. Minus symbol will be shown at the reverse revolutions (when the motor turns in CW direction). <div style="display: flex; justify-content: space-around; align-items: center;"> <div style="text-align: center;"> <input type="text" value="r"/> <input type="text" value="-"/> <input type="text" value="2"/> <input type="text" value="0"/> <input type="text" value="0"/> <input type="text" value="0"/> (Reverse) </div> <div style="text-align: center;"> <input type="text" value="r"/> <input type="text" value=""/> <input type="text" value=""/> <input type="text" value=""/> <input type="text" value=""/> <input type="text" value="0"/> </div> <div style="text-align: center;"> <input type="text" value="r"/> <input type="text" value="2"/> <input type="text" value="0"/> <input type="text" value="0"/> <input type="text" value="0"/> <input type="text" value="0"/> (Forward) </div> </div>
	Accumulated pulses	E	-65000 to 65000 pulse	It shows the number of accumulated pulses of deviation counter. Decimal points will be lighted on all figures of pulses (minus number) at reverse side (CW turns of motor). <div style="display: flex; justify-content: space-around; align-items: center;"> <div style="text-align: center;"> <input type="text" value="E"/> <input type="text" value="6"/> <input type="text" value="5"/> <input type="text" value="0"/> <input type="text" value="0"/> <input type="text" value="0"/> <input type="text" value="0"/> (Reverse) </div> <div style="text-align: center;"> <input type="text" value="E"/> <input type="text" value=""/> <input type="text" value=""/> <input type="text" value=""/> <input type="text" value=""/> <input type="text" value="0"/> </div> <div style="text-align: center;"> <input type="text" value="E"/> <input type="text" value="6"/> <input type="text" value="5"/> <input type="text" value="0"/> <input type="text" value="0"/> <input type="text" value="0"/> <input type="text" value="0"/> (Forward) </div> </div>
	Regenera- tive load ratio	Ld	0 to 100%	It displays % of regenerative power against its allowance value. Since the value varies depending on the existence of regenerative option, it is necessary to set the parameter No.601 correctly. <div style="text-align: center;"> <input type="text" value="L"/> <input type="text" value="d"/> <input type="text" value=""/> <input type="text" value=""/> <input type="text" value="1"/> <input type="text" value="0"/> <input type="text" value="0"/> </div>
	Load ratio	JA	5 to Abt. 400%	It displays the continued effective load torque. Rated torque is equivalent to 100%. <div style="text-align: center;"> <input type="text" value="J"/> <input type="text" value="A"/> <input type="text" value=""/> <input type="text" value=""/> <input type="text" value="1"/> <input type="text" value="0"/> <input type="text" value="0"/> </div>
	Peak load ratio	Jb	0 to Abt. 400%	It shows the peak torque (%) at acceleration, deceleration. Rated motor torque is equivalent to 100%. <div style="text-align: center;"> <input type="text" value="J"/> <input type="text" value="b"/> <input type="text" value=""/> <input type="text" value=""/> <input type="text" value="1"/> <input type="text" value="0"/> <input type="text" value="0"/> </div>

10-2 Diagnosis indication

The diagnosis displays are used, for example, to confirm the state of external sequence, etc.

Table 10-2 List of diagnosis displays

No.	Name	Display	Description																								
301	Operation mode		It displays the operation mode. Motor will not run with any mode other than following modes. 1: Auto mode 2: Manual mode 4: Manual remote or zero return mode 6: Forward/reverse JOG with external signals																								
302	Sequence		Not ready. It is displayed before the power is turned on (servo on), during initializing after servo on or when there was any error.																								
			Ready. It is displayed when it is ready for operation after the power was turned on (servo on) and the initializing was completed.																								
303	External I/O signal		It shows the state of On or Off of external I/O signal. On the 6 digits display, the upper half of vertical lines in each segment indicate the input signal and the lower half corresponds to the output signal. The example at left shows all I/O signals are On. The relations between vertical lines in each segment and I/O signals are as shown below.																								
		<table border="1"> <tr> <td>Name of input signal (CN1 pin No.)</td> <td>SON (9)</td> <td>DEC (10)</td> <td>JFS (11)</td> <td>STP (12)</td> <td>LSP (24)</td> <td>LSN (25)</td> <td>CR (27)</td> <td>DI0 (23)</td> <td>DI1 (42)</td> <td>DI2 (43)</td> <td>ST1 (28)</td> <td>ST2 (29)</td> </tr> <tr> <td>Name of output signal (CN1 pin No.)</td> <td>OP (50)</td> <td></td> <td></td> <td></td> <td></td> <td></td> <td></td> <td></td> <td>CP0 (44)</td> <td>2P (45)</td> <td>PF (48)</td> <td>RD (49)</td> </tr> </table>	Name of input signal (CN1 pin No.)	SON (9)	DEC (10)	JFS (11)	STP (12)	LSP (24)	LSN (25)	CR (27)	DI0 (23)	DI1 (42)	DI2 (43)	ST1 (28)	ST2 (29)	Name of output signal (CN1 pin No.)	OP (50)								CP0 (44)	2P (45)	PF (48)
Name of input signal (CN1 pin No.)	SON (9)	DEC (10)	JFS (11)	STP (12)	LSP (24)	LSN (25)	CR (27)	DI0 (23)	DI1 (42)	DI2 (43)	ST1 (28)	ST2 (29)															
Name of output signal (CN1 pin No.)	OP (50)								CP0 (44)	2P (45)	PF (48)	RD (49)															
304	Digital switch		It shows the state of input with digital switch. Segments, from left to right, correspond to DG5, DG4, DG3, DG2, DG1. Note: The value set with digital switch is effective either when the switch is set to be effective with parameter No.601 or when parameter No.602 (Feed length data) is set at 0. It is displayed all the same if it is disabled.																								
305	S/W version		For the control by maker.																								

Continued on the next page.

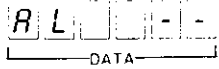
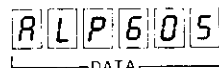
No.	Name	Display	Description
306	Present alarm		<p>It shows the alarm code No. which is happening now. The present alarm will always be displayed with priority over any other display. Example at left shows there is no alarm. This example shows the case when the auto mode operation has been done without conducting zero return. The display can be erased by hitting SET key after the manual zero return has been done.</p>
307	Parameter error		<p>It shows the parameter No. of that error when there was a parameter error and it turned out to be the alarm code AL37. Left example shows that there was a setting error in parameter No.605 (Electron gear denominator). If there is any parameter error, a corresponding error code will be shown with priority over any other display mode.</p>

10-3 Alarm indication

Alarm displays show the history of alarm which is shown in following list or the parameter error.

Table 10-3 List of alarm displays

No.	Name	Display	Description
401 to 410	Alarm history		<p>History of last 9 alarms which is numbered from the present alarm is shown with alarm code No.. Left example shows that the 1st alarm from the present was No.33 alarm (Over-voltage error).</p>

10-4 Parameters

It will be required to change some of parameters depending on the purpose of operation or any special specifications. Parameters can be classified as listed below and, among them, the stored data parameters and user parameters are only provided for change of setting by the user.

Table 10-4 List of parameter

Classification	No.	Symbol	Name	Roll	Position	Initial value	Unit	Remarks
Stored data	501 to 516		Stored data	-		0	$\mu\text{m} \times 10^{\text{STM}}$	
User parameter	*601	OP1	Select specs.	○	○	0003	HEX setting	Roll feed setting (Note 5) Electron gear A/B=1
	602	STX	Feed length	○	○	100	$\mu\text{m} \times 10^{\text{STM}}$	
	603	STM	Feed length magnifier	○	○	1		
	*604	CMX	Pulses per each motor turn	○	○	1	Pulse	
	*605	CDV	Mechanical travel per each motor turn	○	○	1	μm	
	606	PGN	Position loop gain	○	○	25	rad/sec	
	607	VGN	Speed loop gain	○	○	100		
	608	VIC	Speed advance compensation	○	○	20	ms	
	609	SJL	JOG speed L	○	○	10	rpm	
	610	SJH	JOG speed H	○	○	500	rpm	
	611	SFL	Feed speed L	○	○	100	rpm	} Trapezoidal accel'n/decel'n pattern, time constant=0.1 sec.
	612	SFH	Feed speed H	○	○	2000	rpm	
	613	TIA	Accel'n/decel'n time constant A	○	○	100	ms	
	614	TIB	Accel'n/decel'n time constant B	○	○	9999	ms	
	615	TIT	Time constant change time	○	○	0	ms	
	616	2ZA	No.2 zero address	-	○	0	$\mu\text{m} \times 10^{\text{STM}}$	
	617	ZRF	Zero return quick feed speed	-	○	2000	rpm	
	618	CRF	Zero return creep speed	-	○	100	rpm	
	619	ZST	Zero return shift amount	-	○	0	μm	
	620	BKC	Backlash compensation	○	○	0	μm	
	621	CRP	Coarse alignment output range	○	○	0	100 μm	
	622	INP	Positioning complete range	○	○	25	Pulse	
	623	MXP	Stored data positioning steps	-	○	16		
624 to 629			(Spare)			0000		

Continued on the next page.

Classification	No.	Symbol	Name	Roll	Position	Initial value	Unit	Remarks	
Special parameter	*701		} For maker's setting	○	○	0000		Max. torque=100% 1/1,1/2,1/4 dividing select Present position display	
	702			○	○	0000			
	703			○	○	0			
	704	TIL	Torque limit value (internal)	○	○	100	%		
	705		} For marker's setting	○	○	1000			
	706			○	○	210			
	707			○	○	600			
	708			○	○	65			
	709	ENR	Encoder output dividing ratio	○	○	0			1/1,1/2,1/4 dividing select
	710	DMD	Display mode	○	○	0000	HEX setting		Present position display
	711	MOO	Monitor output offset	○	○	0	mv		
	712		For maker's setting	○	○	50			
	713 to 719		(Spare)			0000			
Maintenance parameter	801		} For maker's setting			0		Rightmost digit depending on rated motor revolutions: 2000rpm=2, 3000rpm=3	
	802					###2/3			
	804					1024/2048			
	805					2048			
	806					128/200/ 256/512			
	807					256/512			
	808					5			
	809				0				
	810 to 815		(Spare)			0000			

- Note: 1. When parameters with * have been set, the power shall be turned off. When the display disappeared, back on again the power and the setting is completed. See Section 5-2 (5).
2. Parameter setting or change will not be executed during the present operation. It will become effective only after the motor has been stopped (completion of command).
3. Initial values in the list are applicable to standard series motors. Nos. 606, 801-809 vary depending on the capacity and the series.
4. Among special and maintenance parameters, those for maker's setting are used for the confirmation of detail of error when there were any alarm.
5. Initial value for 7.0kW will be 0203.

10-5 User parameter setting data

Table 10-5

Classification	No.	Abbr.	Name and function	Initial value	Unit	Set range																																																									
Stored data	501 to 516		<p>Stored data: Used to set the position data during the positioning with stored data. Actual value is indicated with a decimal point which has been shifted with parameter No.603.</p>	0	$\mu\text{m} \times 10(\text{STM})$	0 to +999999																																																									
User	601	*OP1	<p>Feed method: Following 16 bits will correspond to each data.</p> <table border="1" style="margin-left: auto; margin-right: auto;"> <tr> <td>F</td><td>E</td><td>D</td><td>C</td><td>B</td><td>A</td><td>9</td><td>8</td><td>7</td><td>6</td><td>5</td><td>4</td><td>3</td><td>2</td><td>1</td><td>0</td> </tr> <tr> <td colspan="2">8 4 2 1</td><td colspan="2">8 4 2 1</td><td colspan="2">8 4 2 1</td><td colspan="2">8 4 2 1</td><td colspan="2">8 4 2 1</td><td colspan="2">8 4 2 1</td><td colspan="2">8 4 2 1</td><td colspan="2">bit</td> </tr> <tr> <td colspan="4" style="text-align: center;">4th from right</td> <td colspan="4" style="text-align: center;">3rd from right</td> <td colspan="4" style="text-align: center;">2nd from right</td> <td colspan="4" style="text-align: center;">(Right-most)</td> </tr> </table> <p>(Digital switch) (Regenerative option) (Motor turn direction override) (Feed direction method)</p>	F	E	D	C	B	A	9	8	7	6	5	4	3	2	1	0	8 4 2 1		8 4 2 1		8 4 2 1		8 4 2 1		8 4 2 1		8 4 2 1		8 4 2 1		bit		4th from right				3rd from right				2nd from right				(Right-most)				<p>0003 Roll feed increment setting/without regenerative option/0.2-5.0kW 0203 (7.0kW)</p>		HEX setting									
F	E	D	C	B	A	9	8	7	6	5	4	3	2	1	0																																																
8 4 2 1		8 4 2 1		8 4 2 1		8 4 2 1		8 4 2 1		8 4 2 1		8 4 2 1		bit																																																	
4th from right				3rd from right				2nd from right				(Right-most)																																																			
<table border="1" style="width: 100%; border-collapse: collapse;"> <thead> <tr> <th>Data</th> <th>Bit</th> <th>Content</th> <th>Setting</th> </tr> </thead> <tbody> <tr> <td rowspan="3">Right-most</td> <td>0</td> <td>Feed method (Note 1)</td> <td>0: Positioning method 1: Roll feed</td> </tr> <tr> <td>1</td> <td>Coordinate</td> <td>0: Absolute 1: Increment</td> </tr> <tr> <td>2</td> <td>Stored data (Note 2)</td> <td>0: Ineffective 1: Effective</td> </tr> <tr> <td rowspan="3">2nd</td> <td>3</td> <td></td> <td></td> </tr> <tr> <td>4</td> <td>Motor turn direction (Note 3)</td> <td>0: Motor CCW with forward start ST1 1: CW</td> </tr> <tr> <td>5</td> <td></td> <td></td> </tr> <tr> <td rowspan="3">3rd</td> <td>6</td> <td>Speed override</td> <td>0: Ineffective 1: Effective</td> </tr> <tr> <td>7</td> <td></td> <td></td> </tr> <tr> <td>8</td> <td>Regenerative option MR-RB30</td> <td>0: - 1: With regenerative option MR-RB 30</td> </tr> <tr> <td rowspan="3">4th</td> <td>9</td> <td>Regenerative option MR-RB50, 51</td> <td>0: - 1: With regenerative option MR-RB 50, 51</td> </tr> <tr> <td>A</td> <td></td> <td></td> </tr> <tr> <td>B</td> <td></td> <td></td> </tr> <tr> <td rowspan="4">4th</td> <td>C</td> <td>Digital switch</td> <td>0: Ineffective 1: Effective</td> </tr> <tr> <td>D</td> <td></td> <td></td> </tr> <tr> <td>E</td> <td></td> <td></td> </tr> <tr> <td>F</td> <td></td> <td></td> </tr> </tbody> </table> <p>Note 1. With roll feed, the coordinate setting is limited to increment method. Note 2. With stored data positioning, coordinate setting is limited to absolute method. Note 3. Forward start means that the present position progresses.</p>							Data	Bit	Content	Setting	Right-most	0	Feed method (Note 1)	0: Positioning method 1: Roll feed	1	Coordinate	0: Absolute 1: Increment	2	Stored data (Note 2)	0: Ineffective 1: Effective	2nd	3			4	Motor turn direction (Note 3)	0: Motor CCW with forward start ST1 1: CW	5			3rd	6	Speed override	0: Ineffective 1: Effective	7			8	Regenerative option MR-RB30	0: - 1: With regenerative option MR-RB 30	4th	9	Regenerative option MR-RB50, 51	0: - 1: With regenerative option MR-RB 50, 51	A			B			4th	C	Digital switch	0: Ineffective 1: Effective	D			E			F		
Data	Bit	Content	Setting																																																												
Right-most	0	Feed method (Note 1)	0: Positioning method 1: Roll feed																																																												
	1	Coordinate	0: Absolute 1: Increment																																																												
	2	Stored data (Note 2)	0: Ineffective 1: Effective																																																												
2nd	3																																																														
	4	Motor turn direction (Note 3)	0: Motor CCW with forward start ST1 1: CW																																																												
	5																																																														
3rd	6	Speed override	0: Ineffective 1: Effective																																																												
	7																																																														
	8	Regenerative option MR-RB30	0: - 1: With regenerative option MR-RB 30																																																												
4th	9	Regenerative option MR-RB50, 51	0: - 1: With regenerative option MR-RB 50, 51																																																												
	A																																																														
	B																																																														
4th	C	Digital switch	0: Ineffective 1: Effective																																																												
	D																																																														
	E																																																														
	F																																																														
	602	STX	<p>Feed length: Used to set the feed length during auto operation. Actual feed length will be indicated with a decimal point which has been shifted with parameter STM. Content of this setting can be changed with FEED LENGTH key of key setter. If 0 is set, it can be set with external digital switch.</p>	100	μm	0 to 999999																																																									

Continued on the next page.

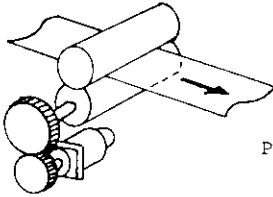
Classification	No.	Abbr.	Name and function	Initial value	Unit	Set range																																
User	603	STM	<p>Feed length magnifier: Used to set the decimal point for feed length set with parameter STX. Relations between STX, STM set values and the actual travel are as shown below.</p> <div style="border: 1px solid black; padding: 5px; width: fit-content; margin: 10px auto;"> $\text{Actual travel}(\mu\text{m}) = [\text{STX value}] \times 10^{[\text{STM value}]}$ </div> <table border="1" style="margin: 10px auto; border-collapse: collapse;"> <thead> <tr> <th>STM value</th> <th>Actual travel (μm)</th> <th>Decimal point position (position in mm)</th> </tr> </thead> <tbody> <tr> <td>0</td> <td>STX x 1</td> <td>999.999</td> </tr> <tr> <td>1</td> <td>STX x 10</td> <td>9999.99</td> </tr> <tr> <td>2</td> <td>STX x 100</td> <td>99999.9</td> </tr> <tr> <td>3</td> <td>STX x 1000</td> <td>999999.</td> </tr> </tbody> </table>	STM value	Actual travel (μm)	Decimal point position (position in mm)	0	STX x 1	999.999	1	STX x 10	9999.99	2	STX x 100	99999.9	3	STX x 1000	999999.	1		0, 1, 2, 3																	
STM value	Actual travel (μm)	Decimal point position (position in mm)																																				
0	STX x 1	999.999																																				
1	STX x 10	9999.99																																				
2	STX x 100	99999.9																																				
3	STX x 1000	999999.																																				
	*604	CMX	Pulses per each motor turn (Electron gear numerator) (See the next section for an example)	1	Pulse	1 to 9999																																
	*605	CDV	<p>Mechanical travel per each motor turn (Electron gear denominator)</p> <p>EXAMPLE OF SETTING</p>  <p>Roll dia. 50mm Reducing ratio 3/7 Pulses 12000 pulses/rev.</p> $\frac{\text{Pulses (CMX)}}{\text{Travel (CDV)}} = \frac{12000}{50 \times \pi \times 3/7 \times 1000} = \frac{14}{25\pi} \approx \frac{1400}{7854}$ <p>Thus, it must be set CMX=1400, CDV=7854. (Note) There is a fraction, take an upper figure with the set range and round up the fraction.</p>	1	μm	1 to 9999																																
	606	PGN	<p>Position loop gain: Used to set the position loop gain.</p> <table border="1" style="margin: 10px auto; border-collapse: collapse;"> <thead> <tr> <th colspan="2">$\text{GD}^2\text{L}/\text{GD}^2\text{M}$</th> <th>0</th> <th>1</th> <th>3</th> <th>5</th> </tr> </thead> <tbody> <tr> <td rowspan="2">Set value</td> <td>Standard</td> <td>35</td> <td>35</td> <td>25</td> <td>15</td> </tr> <tr> <td>Max.</td> <td>100</td> <td>80</td> <td>40</td> <td>25</td> </tr> </tbody> </table>	$\text{GD}^2\text{L}/\text{GD}^2\text{M}$		0	1	3	5	Set value	Standard	35	35	25	15	Max.	100	80	40	25	25	rad/sec	5 to 150															
$\text{GD}^2\text{L}/\text{GD}^2\text{M}$		0	1	3	5																																	
Set value	Standard	35	35	25	15																																	
	Max.	100	80	40	25																																	
	607	VGN	<p>Speed loop gain: Used to set the speed loop gain.</p> <table border="1" style="margin: 10px auto; border-collapse: collapse;"> <thead> <tr> <th colspan="2">$\text{GD}^2\text{L}/\text{GD}^2\text{M}$</th> <th>0</th> <th>1</th> <th>3</th> <th>5</th> </tr> </thead> <tbody> <tr> <td rowspan="2">Set value</td> <td>Standard</td> <td>0.2, 0.3kW</td> <td>70</td> <td>70</td> <td>150</td> <td>200</td> </tr> <tr> <td></td> <td>0.5 to 7.0kW</td> <td>100</td> <td>100</td> <td>200</td> <td>300</td> </tr> <tr> <td rowspan="2">value</td> <td>Low inertia</td> <td>0.3 to 3.0kW</td> <td>30</td> <td>30</td> <td>60</td> <td>100</td> </tr> <tr> <td>flat</td> <td>5.0, 7.0kW</td> <td>50</td> <td>50</td> <td>100</td> <td>150</td> </tr> </tbody> </table>	$\text{GD}^2\text{L}/\text{GD}^2\text{M}$		0	1	3	5	Set value	Standard	0.2, 0.3kW	70	70	150	200		0.5 to 7.0kW	100	100	200	300	value	Low inertia	0.3 to 3.0kW	30	30	60	100	flat	5.0, 7.0kW	50	50	100	150	Set $\text{GD}^2\text{L}/\text{GD}^2\text{M} = 1$		20 to 500
$\text{GD}^2\text{L}/\text{GD}^2\text{M}$		0	1	3	5																																	
Set value	Standard	0.2, 0.3kW	70	70	150	200																																
		0.5 to 7.0kW	100	100	200	300																																
value	Low inertia	0.3 to 3.0kW	30	30	60	100																																
	flat	5.0, 7.0kW	50	50	100	150																																

Continued on the next page.

Classification	No.	Abbr.	Name and function	Initial value	Unit	Set range										
User	608	VIC	Speed integral compensation: Used to set the time constant at integral compensation. <table border="1" data-bbox="507 409 951 499"> <tr> <td>GD^2_L/GD^2_M</td> <td>0</td> <td>1</td> <td>3</td> <td>5</td> </tr> <tr> <td>Set value</td> <td>20</td> <td>20</td> <td>30</td> <td>40</td> </tr> </table>	GD^2_L/GD^2_M	0	1	3	5	Set value	20	20	30	40	20	msec	1 to 1000
	GD^2_L/GD^2_M	0	1	3	5											
	Set value	20	20	30	40											
	609	SJL	Slow JOG speed: Used to set JOG speed (slow side) during manual mode operation. It is clamped with rated revolutions.	10	rpm	0 to Rated revolution										
	610	SJH	High JOG speed: Used to set JOG speed (high side) during manual mode operation. It is clamped with rated revolutions.	500	rpm	0 to Rated revolution										
	611	SFL	Slow feed speed: Used to set the feed speed (slow side) during auto mode operation. This can be set also directly with SPEED key of key setter (MR-SU).	100	rpm	0 to Rated revolution										
	612	SFH	High feed speed: Used to set the feed speed (high side) during auto mode operation. Acceleration time constant (T1A, T1B) during auto mode operation. Acceleration time constant (T1A, T1B) will be a time to reach the speed set with SFH.	2000	rpm	0 to Rated revolution										
613	T1A	Accel'n/decel'n time constant A ◦Used to set the time constant at trapezoidal accel'n/decel'n. ◦At the pseud S accel'n/decel'n, it is used to set the slope after the time to change time constant (parameter T1T) has passed. (See the figure of parameter No.615)	100	ms	0 to 9999											
614	T1B	Accel'n/decel'n time constant B: At the pseud S deceleration, it is used to set the slope of touch up. At the trapezoidal accel'n/decel'n, it is set at the max. (9999). (See the figure of parameter No.615)	9999	ms	0 to 9999											

Continued on the next page.

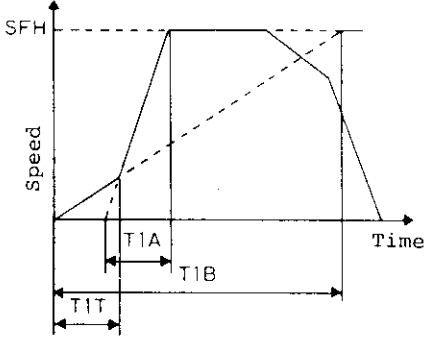
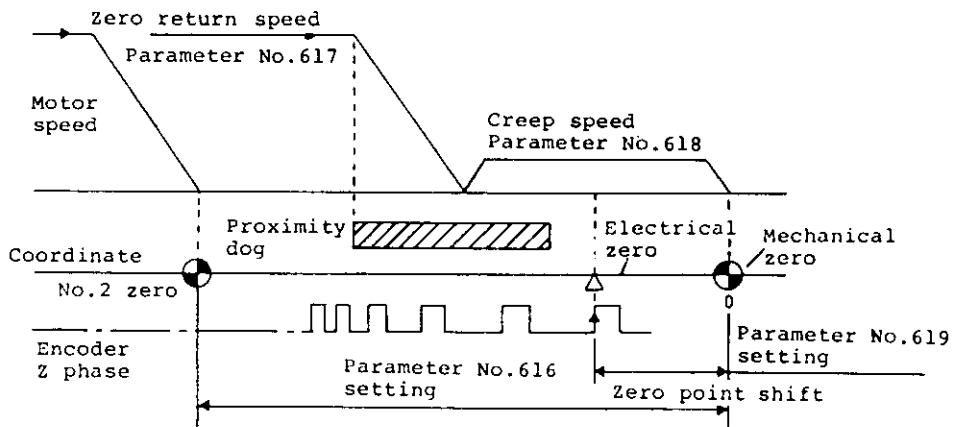
Classification	No.	Abbr.	Name and function	Initial value	Unit	Set range
User	615	TlT	<p>Time to change time constant of accel'n/decel'n: Used to set the pseud S accel'n/decel'n. It is set at 0 for trapezoidal accel'n/decel'n. Slope of accel'n/decel'n will be the time constant set with either TlB or TlA depending on before or after TlT time. (See the figure)</p>  <p>Note 1: When the shockless is required at the pseud S accel'n/decel'n, it will be ineffective unless TlT > 50ms. 2. At the trapezoidal accel'n/decel'n, it must be set as TlT=0, TlB=9999.</p>	0	ms	0 to 9999
	616	2ZA	<p>No.2 zero point: Used to set the address of No.2 zero against mechanical zero. Actual zero position is the set value multiplied with 10^{STM}. Setting will be effective only with (+).</p>	0	$\mu\text{m} \times 10^{STM}$	0 to 65535
	617	ZRF	<p>Zero return speed: Used to set zero return speed.</p>	2000	rpm	0 to Rated revolution
	618	CRF	<p>Creep speed: Used to set creep speed at zero return.</p>	100	rpm	0 to Rated revolution
	619	ZST	<p>Zero point shift: Used to set the distance between encoder's Z phase pulse detect position (electrical zero) and mechanical zero (address 0).</p> 	0	μm	0 to 65535

Classification	No.	Abbr.	Name and function	Initial value	Unit	Set range
User	620	BKC	Backlash compensation: Used to set the backlash for compensation at reversing the commanded direction of turn.	0	μm	0 to 10000
	621	CPO	Coarse alignment output range: Used to set the commanded remaining distance to output rough concordance signal.	0	100μm	0 to 65535
	622	INP	Positioning complete range: Used to set the accumulated pulses range to output positioning complete signal.	25	Pulse	1 to 9999
623	MPX	Stored data positioning steps: Used to set the number of effective steps at the positioning with stored data. Any other data after the set step is neglected and the positioning is conducted based on the data of step 1.	16		1 to 16	

10-6 Special parameter data

Table 10-6

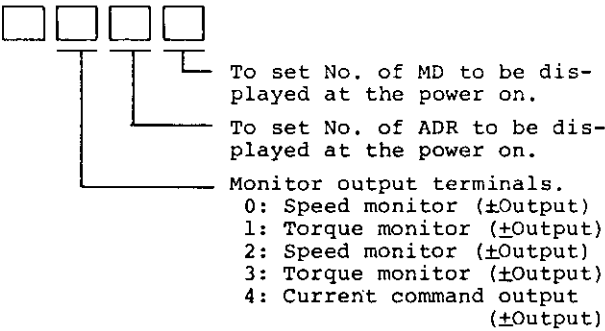
Classification	No.	Abbr.	Name and function	Initial value	Unit	Set range
Special	701		For setting by maker	0000		
	702		For setting by maker	0000		
	703		For setting by maker	0		
	704	T1L	Torque limit value: Used to set the torque limit value on the basis that the max torque of motor is equal to 100%.	100	%	0 to 100
	705		For setting by maker	1000		
	706		For setting by maker	210		
	707		For setting by maker	600		
	708		For setting by maker	65		
	709	ENR	Encoder output dividing ratio: Used to set the pulse dividing ratio of encoder output. It is 3000 pulses/rev. with dividing ratio of 1/1. 0: 1/1 dividing 1: 1/2 2: 1/4	0		0, 1, 2
	710	DMD	Display mode: Used for setting related with display and output. 	0000		HEX setting
	711	MOO	Monitor output offset: Used to set offset value of monitor output.	0	mV	-999 to 999
	712		For setting by maker	50		

10-7 Parameter setting value entry table

Classification	No.	Name	Initial value	Unit	Setting by user	Remarks
stored data	501	Stored data 1	0	$\mu\text{m} \times 10^{\text{STM}}$		
	502	2	0			
	503	3	0			
	504	4	0			
	505	5	0			
	506	6	0			
	507	7	0			
	508	8	0			
	509	9	0			
	510	10	0			
	511	11	0			
	512	12	0			
	513	13	0			
	514	14	0			
	515	15	0			
	516	16	0			
User parameter	*601	Select specs.	0003	HEX set		
	602	Feed length	100	$\mu\text{m} \times 10^{\text{STM}}$		
	603	Feed length magnifier	1			
	*604	Pulses per each motor turn	1	Pulse		
	*605	Mechanical travel per each motor turn	1	μm		
	606	Position loop gain	25	rad/sec		
	607	Speed loop gain	100			
	608	Speed advance compensation	20	ms		
	609	JOG speed L	10	rpm		
	610	JOG speed H	500	rpm		
	611	Feed speed L	100	rpm		
	612	Feed speed H	2000	rpm		
613	Accl'n/decl'n time constant A	100	ms			
614	Accl'n/decl'n time constant B	9999	ms			
615	Time constant change time	0	ms			
616	No.2 zero address	0	$\mu\text{m} \times 10^{\text{STM}}$			
617	Zero return quick feed speed	2000	rpm			
618	Zero return creep speed	100	rpm			

Continued on the next page.

Classification	No.	Name	Initial value	Unit	Setting by user	Remarks
User parameter	619	Zero point shift	0	μm		
	620	Backlash compensation	0	μm		
	621	Rough concordance output range	0	100μm		
	622	Positioning complete range	25	Pulse		
	623	Stored data positioning steps	16			
	*701	702	} Maker's setting	0000		
703		0000				
704		0				
Special parameter	705	Torque limit value (internal)	100	%		
	706	} Maker's setting	1000			
	707		210			
	708		600			
	709		65			
	710	Encoder output dividing ratio	0			
711	Display mode	0000	HEX set			
712	Monitor output offset	0	mV			
		Maker's setting	50			

Note 1. Parameters with * require to turn off the power after setting. The setting becomes effective when the power is backed on again. See Section 5-2(5)

2. Setting of user parameter No.601

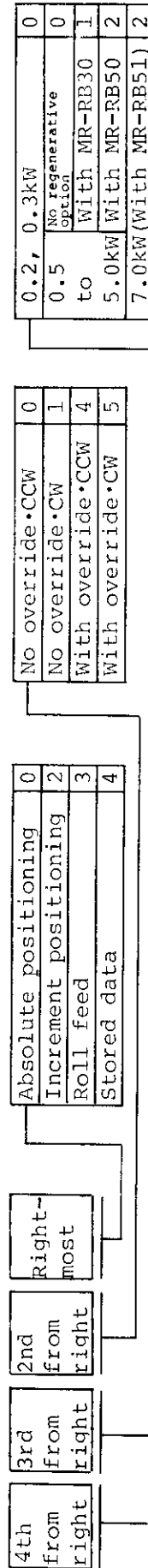

For 0.2 to 5.0kW

Data of [00]03 of marked section shows the initial value.

Digital switch disabled	0
Digital switch effective	1



MITSUBISHI ELECTRIC CORPORATION

HEAD OFFICE: MITSUBISHI DENKI BLDG., MARUNOUCHI, TOKYO 100. TELEX: J24532 CABLE: MELCO TOKYO

These products or technologies are subject to Japanese and/or COCOM strategic restrictions and diversion contrary thereto is prohibited.